

Owner's Manual

Includes the Installation, Operation, Maintenance,
and Service of Legion's

Electric Self-Contained Steam Jacketed Kettle

LEZ/HEZ
TWE

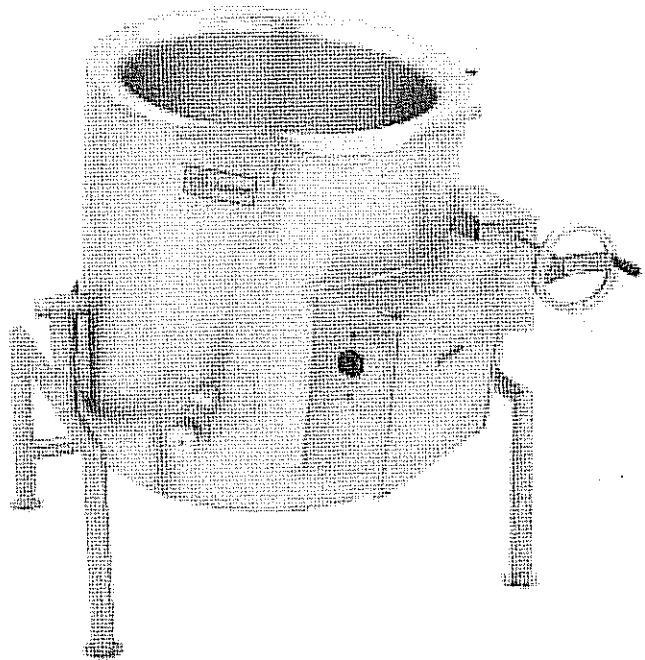
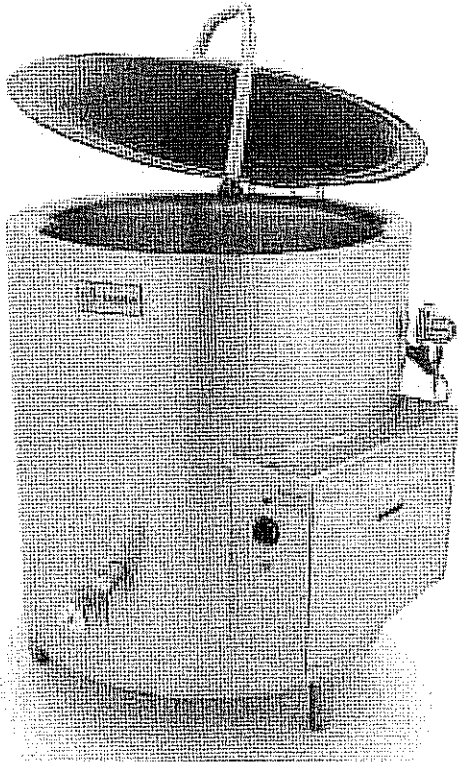

LEGION®

LEGION INDUSTRIES, INC. ♦ 370 MILLS RD. ♦ WAYNESBORO, GA 30830 ♦ (800) 309-4895 ♦
(706) 554-4411 ♦ FAX: (706) 554-2035 ♦ www.legionindustries.com

IMPORTANT!

Uncrating & Inspecting the Equipment

Legion Industries, Inc. is not responsible for loss or damage incurred in transit. The unit has been assembled, tested, and inspected at the factory prior to shipment. Do not pay the freight bill until the shipment has been thoroughly inspected!

Uncrate the equipment carefully and inspect for any damage. Also check the contents against the packing list to make sure all accessories are included.

Important: *The carrier is responsible for any shipping damage or lost parts during transit, whether visible or concealed. You, as the recipient, are responsible for inspection and for filing all claims with the carrier.*

Visible Loss/Damage: Be certain to note this on the freight or express receipt and have it signed by the delivery person. File a claim for damages immediately, regardless of the extent of damage.

Concealed Loss/Damage: If damage is noticed after the equipment is unpacked, notify the freight company and file a concealed damage claim. This must be done immediately. Be sure to retain the shipping container for inspection.

Table of Contents

Uncrating & Inspecting the Equipment	ii
Introduction	iv
Safety Precautions	1
Important Warranty Information	2
Service Calls	3
Section I: Installation	4
1. Positioning the Unit	4
Fig. 1.1: Minimum Clearances	4
2. Leveling & Securing the Unit	4
3. Electrical Connection	4
4. Completing the "Installation Checklist"	5
SECTION II: START-UP & OPERATION	6
1. Initial Cleaning	6
<i>Removing & Cleaning the Draw-Off Valve:</i>	7
2. Control Functions	7
Fig. 2.1: Control Panel Features	7
<i>Summary of Control Functions:</i>	8
<i>How to Start Cooking:</i>	8
Section III: Service & Maintenance	9
1. Servicing	9
A) <i>Replacing Primary Thermostat</i>	9
2. Actuator Maintenance and Adjustment	11
A) <i>Actuator Tension Adjustment</i>	11
B) <i>Actuator: Re-Packing With Grease</i>	11
Fig. 3.1: Actuator Components & Assembly	12
C) <i>Actuator Replacement</i>	12
Fig. 3.2: Removing/Installing Actuators	12
3. Filling Steam Jacket	13
4. Main and Worm Gear (Model TWE Only)	13
Section IV: Caring For Stainless Steel	14
Section V: Troubleshooting	15
1. Troubleshooting-General Problems	15
Section VI: Parts List	16
1. General Parts List	16
2. Actuator Parts List & Assembly	16
Fig. 6.1: Actuator Assembly Diagram	16
3. Compression Draw-Off Parts List & Assembly	17
Fig. 6.2: Compression Draw-Off Assembly Diagram	17
4. Electrical Data Table	18
For Your Use & Review	21
Installation Checklist	21
Maintenance & Service Log	22
Legion Limited Warranty and Extended Warranty Coverage	23
Legion Limited Warranty and Extended Warranty Coverage - Canada	24

Introduction

Congratulations on your Legion equipment purchase. This manual covers the installation, operation, and maintenance of the Electric Self-Contained Steam Jacketed Kettle.

This manual contains complete information. By reviewing it thoroughly and following its guidelines, your equipment will provide you with a lifetime of dependable use.

IMPORTANT! There are three things you need to do as soon as possible after receiving and/or installing your equipment, since they affect your warranty coverage.

1. Send in your "Warranty Registration Card." This is vital and necessary in the processing of any future service required on your equipment.
2. Complete the "Installation Checklist," contained in this manual, at the time of installation. This is necessary for your warranty to be valid.
3. Record the model number, serial number, and installation date for your unit and file this information for future reference. Space for these entries is provided at the top of the "Maintenance and Service Log" included at the end of this manual.

If, at any time, you have questions about warranty coverage, operating procedures, service, repairs, or maintenance, contact:

Legion's Customer Service Department
Post Office Box 728
Waynesboro, Georgia, 30830

Phone: (800) 887-1988
Fax: (706) 554-2035

Email: service@legionindustries.com

Once again we thank you for the purchase of your equipment. From its versatility, safety features, and durable construction, to its time-tested performance and full HACCP compliance, you've selected the finest equipment available. We know it will provide you with reliable, efficient service for years to come.



Charles Brown
President
Legion Industries, Inc.

PS: Please visit our web site @ www.legionindustries.com

Safety Precautions

- ◆ Installation of the equipment must be done by a qualified technician, knowledgeable of and experienced in the installation of commercial gas and electrical cooking equipment.
- ◆ Retain this manual for future reference.

Positioning Precautions

- ◆ The unit must be placed on a non-combustible floor, under an exhaust hood, with a fire retardant system and all connections and placement must comply with all applicable local and national codes. Your ventilation hood, when installed, must conform to ANSI/UL 705 and ANSI/NFPA 96 (latest edition).
- ◆ Adequate clearance for servicing and proper operation must be maintained.

Electrical Precautions

- ◆ This equipment must be electrically grounded in accordance with local codes or, in the absence of local codes, with the National Electrical Code, ANSI/NFPA No. 70 (latest edition).
- ◆ The incoming power supply voltage range must not exceed plus or minus 5 percent of the unit's voltage rating.

General Use Precautions

- ◆ Always instruct employees on the proper use of this equipment.
- ◆ Never attempt to move this equipment when it is full of hot oil or another hot liquid.
- ◆ Never operate this equipment during a power failure.
- ◆ This equipment is intended for other than household use.

Warning & Operating Plates

- ◆ All warning and operating plates on the equipment should be in place at all times. If plates are damaged or lost, replace them immediately.

Product Improvements

- ◆ Be aware that as continuous product improvement occurs, specifications may be changed without notice.

Important Warranty Information

The Legion Limited Warranty is valid in the Continental United States and Hawaii and is void elsewhere. A *complete* statement of warranty terms and conditions is included in this manual. However, to ensure that you are familiar with the installation, maintenance, and other important warranty-related conditions, please study the following.

The instructions in this manual must be read thoroughly before attempting installation, operation, maintenance, or service. Legion Industries, Inc. reserves the right to render void any warranty on equipment not installed in accordance with the manual by a qualified technician, knowledgeable of and experienced in the installation of commercial gas and electrical cooking equipment.

Legion products are built to comply with applicable standards of manufacturers. Many local codes exist and it is the responsibility of the equipment owner and installer to comply with these codes.

If the equipment has been changed, altered, modified, or repaired by other than a qualified service technician during or after the one year limited warranty period, Legion Industries, Inc. shall not be liable for any incidental or consequential damages to any person or to any property which may result from the use of the equipment thereafter.

The Limited Warranty does not extend to:

1. Installation and start-up. Proper installation is the responsibility of the owner/installer. Repair services for the same will not be covered.
2. Malfunction as a result of improper maintenance.
3. Failure as a result of improper use or abuse of equipment.
4. Repair services initiated without prior authorization from Legion.
5. Repair services for problems caused by inadequate gas supply pressure or low voltage supply.
6. Repairs made by anyone other than qualified service personnel recommended by Legion.
7. Damage caused in shipment.
8. Repair services for problems caused by routine maintenance or cleaning.
9. Damage caused by tampering with, removing, or changing a preset control or safety device.
10. Damage caused by hitting the cooking surface with implements or by rubbing or scraping the cooking surface with abrasive materials.
11. Damage caused by simple adjustments, such as actuator adjustments.
12. Lubrication of grease fittings or actuator springs and gears. These parts should be greased at least once every six months.
13. Moving other equipment to gain access to the unit.
14. Damages to any part of the unit as a result of cleaning with high-pressure water or steam. *Do not spray the exterior of the equipment with water or steam!*
15. Use of any replacement parts other than those supplied or authorized by Legion voids all warranties and can cause bodily injury to the operator and damage to the equipment.

Refer to your warranty statement for those items that are covered for only a 90-day period.

Service Calls

All repair services under Legion's Limited Warranty must be authorized in advance by Legion or performed by Legion. Authorization may be obtained by calling:

(800) 887-1988

(within the Continental U.S. and Hawaii)

8 a.m. through 5 p.m. (EST), Monday through Friday

When calling, please have the following information available:

- ◆ name, address, and telephone number of the end-user;
- ◆ location of the product;
- ◆ name, model number, and serial number of the product;
- ◆ description of the problem or defect.

Legion will then issue a service authorization work order number to one of its approved independent servicing organizations or request that the product or part be shipped to Legion for repair or replacement, as appropriate. Any defective part subject to a claim under the Limited Warranty must be shipped freight prepaid to Legion for testing and examination. Legion's decision as to the cause and nature of any defect under this Limited Warranty shall be final.

Section I: Installation

IMPORTANT! Installation of the equipment must be done by a qualified technician, knowledgeable of and experienced in the installation of commercial gas and electrical cooking equipment. It is the responsibility of the owner and installer to comply with all applicable local and national codes and regulations when installing the unit.

All internal wiring of the equipment is supplied complete and ready for final connection. A wiring diagram is supplied behind the cover of the unit's control console. Legion's Engineering Department must approve any mechanical or electrical changes.

1. Positioning the Unit

WARNING:

- The unit must be placed on a non-combustible floor, under an exhaust hood, with a fire retardant system and all connections and placement must comply with all applicable local and national codes. Your ventilation hood, when installed, must conform to ANSI/UL 705 and ANSI/NFPA 96 (latest edition).
- Adequate clearance for servicing and proper operation must be maintained.

Position the unit where you intend to use it. A minimum of fifteen (15) inches must be provided for servicing of controls. Remember to also consider the required clearances of any other *adjoining* pieces of equipment.

Fig. 1.1: Minimum Clearances

Model	Back of Unit	Sides of Unit
LEC / HEC	4.0"	15"
TWE	7.0"	15"

2. Leveling & Securing the Unit

Caution!

Do not use the plumbing connections or the handwheel as a lever when positioning the unit.

The feet of the unit may be adjusted so that the kettle is properly leveled.

3. Electrical Connection

WARNING:

- This equipment must be electrically grounded in accordance with local codes or, in the absence of local codes, with the National Electrical Code, ANSI/NFPA No. 70 (latest edition) or the Canadian Electrical Code, CSA C22.1 (latest edition), as applicable.
- Also, it is required that an electrical cut-off device, such as a fused disconnect switch or equivalent, be installed in the power supply line between the main power supply and the unit.
- The incoming power supply voltage range must not exceed plus or minus 5 percent of the unit's voltage rating.

A junction box is provided on the back of the unit, for connecting to the electric power supply. The installer should verify the electrical requirements of the unit to make sure your power supply line is capable of powering the equipment properly. This information is listed on the unit's nameplate.

Power connection for this unit must be in accordance with local codes or, in the absence of local codes, with the National Electrical Code, ANSI/NFPA No. 70 (Latest Edition).

The power supply may be connected

- a. directly to the supplied pigtail
- or
- b. Remove the cover off the front of the junction box. Feed the power supply wire through the bottom of the junction box. Connect the wires and secure with screw caps. A complete wiring schematic is provided inside the cover of the unit's control console. Replace the junction box cover and tighten the screws securely.

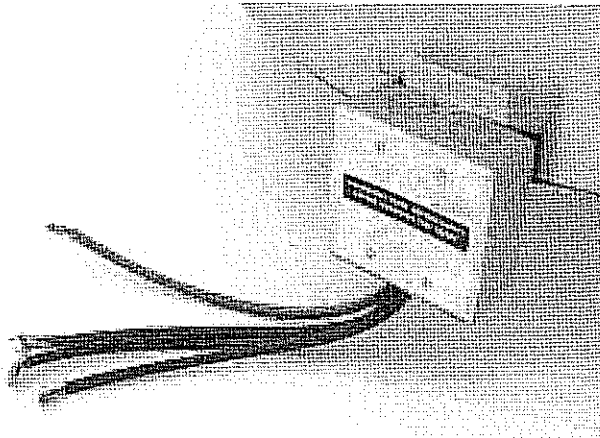

4. Completing the "Installation Checklist"

With all of the preceding installation steps completed, the primary aspects of the installation have been completed. This manual contains an *Installation Checklist* that must be filled out to show that certain key elements of the installation have been performed properly. **IMPORTANT!** The Installation Checklist must be completed for your warranty to be valid. Do not neglect this step.

SECTION II: START-UP & OPERATION

Warning:

- Always disconnect power before cleaning (or servicing) the unit.
- The control console is not waterproof. Never spray the control console, electrical controls, ignition system controls, or connections with water. Clean these areas by wiping them with a clean, damp cloth.
- When cooking, never allow water or food stuff to come in contact with any electrical components.

1. Initial Cleaning

Before operating your equipment, it must be cleaned thoroughly. Refer to SECTION IV: CARING FOR STAINLESS STEEL for instructions.

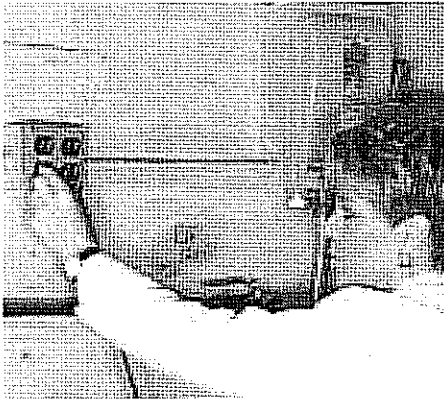

IMPORTANT! Disconnect all electrical power before cleaning the unit.

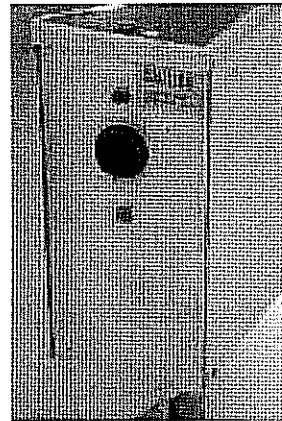

Clean the unit thoroughly with a mild detergent solution. Always "wipe" around control console (never spray). Never rinse control consoles with a spray hose or let water come in contact with any electrical and control components.

For routine cleaning, Legion's optional "Care Kit" accessories help you thoroughly clean all surfaces, including the inside of the lid and the inside of the draw-off valve. During washing, excess water in the kettle may be drained away through the draw-off using the optional *drain hose* attachment.

Use the "Care Kit" to clean hard to reach places like inside the lid and inside the draw-off valve. Rinse and drain away wastewater easily through the optional drain hose.

Take care when removing the draw-off valve for cleaning. The draw-off hex bonnet nut and valve stem are surprisingly heavy. Do not drop them, since this can cause damage to the stem creating leaks. Also be sure to remove all water from the kettle before removing the draw-off valve.

Removing & Cleaning the Draw-Off Valve:

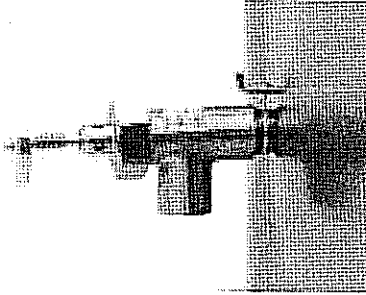

1. Make sure the stem is in the open position.

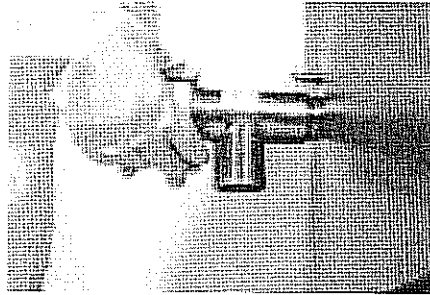

2. Unscrew the hex bonnet nut.

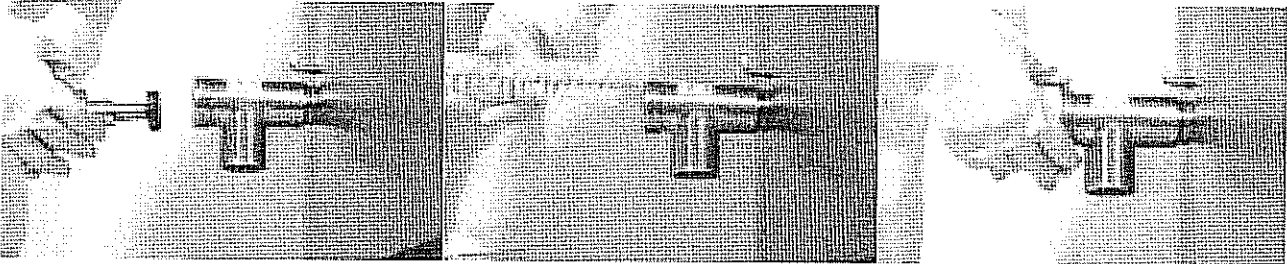

3. Carefully remove the nut and stem assembly. 4. Thoroughly clean the body and tube using the draw-off cleaner brush provided with the Legion Care Kit. 5. When through, rinse with clean water and re-assemble, taking care never to over-tighten the draw-off. It is designed to be hand-tightened only.

2. Control Functions

Now we'll examine all control functions, step by step, for a full understanding.

IMPORTANT: After installation or service and prior to operating the unit, make sure the following is done, otherwise the unit will not operate.

- Make sure the main electrical power to the unit has been turned on.

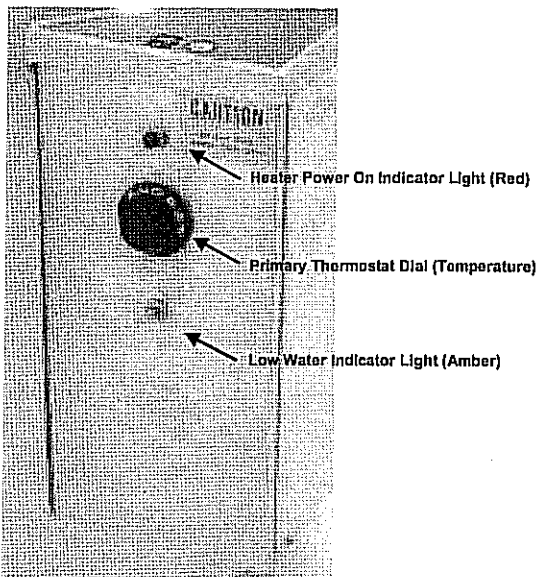

Fig. 2.1: Control Panel Features

Summary of Control Functions:

- ◆ *Primary Thermostat Dial (Temperature)*. Allows the user to set the cooking temperature of the unit.
- ◆ *Heater Power On Indicator Light (Red)*. Illuminates upon turning up the thermostat to show that the infrared burners are operating. Note: If the temperature of the unit is already above the set temperature, the red HEATER POWER ON light will not come on.
- ◆ *Low Water Indicator Light (Amber)*. It alerts the user that the water level in the steam jacket has fallen below the recommended operating level and that the low water relay has been activated, turning off the burner as a safety precaution until the low water condition has been remedied (Refer to Section III, Service & Maintenance, Item 3, Filling the Steam Jacket). Once the water level has been increased to normal working levels the low water relay will reset and permit normal operation.
- ◆ *Tilt Switch (TWE Only)*. Automatically shuts off the kettle when tilted. Care should be taken when tilting unit filled with hot product.

How to Start Cooking:

1. Turn the *primary thermostat* dial clockwise to the desired temperature. This will cause the red heater power on indicator light to come on, showing that the heaters are operating.
2. Close the lid to speed up the heating process.
3. Once the unit has cycled (the red heater power on indicator light goes out), you can start cooking immediately. However, to guarantee the most even, stable heat you may want to let it cycle several times.
4. If a new temperature is desired during a cooking operation, simply turn the primary thermostat dial to the new setting. Again, allow several cycles to ensure proper heat stabilization.
5. To shut down the unit, turn the primary thermostat dial to OFF.

Section III: Service & Maintenance

This section covers the basics of servicing and maintaining your equipment. A "Maintenance and Service Log" is included in this manual for your use in recording all maintenance and service performed.

IMPORTANT: Service must be done by a qualified technician experienced with commercial gas and electric cooking equipment. Use only Legion supplied parts. Unauthorized or generic parts can cause bodily injury and equipment damage. If the unit ever needs repair during the warranty period, prior authorization from Legion is required. Also refer to the sections of this manual entitled *Service Calls* and also *Important Warranty Information*.

1. Servicing

A) Replacing Primary Thermostat

Re-Calibrating Thermostats (Do Not Attempt)

IMPORTANT! If thermostat is defective or not working properly, it must be replaced (without breaking the seal) and returned to Legion. The warranty is voided if the seal is broken or any attempt is made to recalibrate a thermostat. See below for replacement instructions.

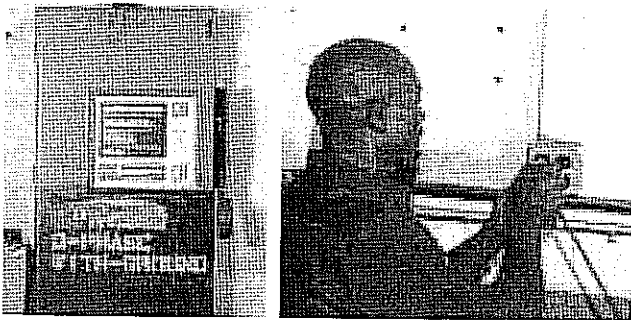

1. Disconnect the unit from its power supply.

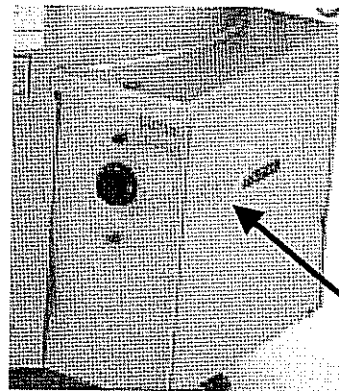

2. Remove control console panel.

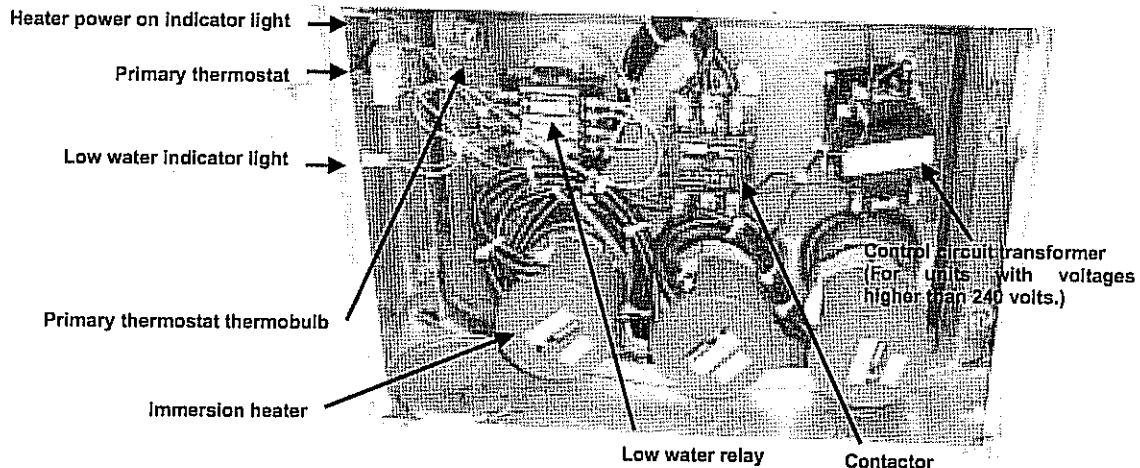

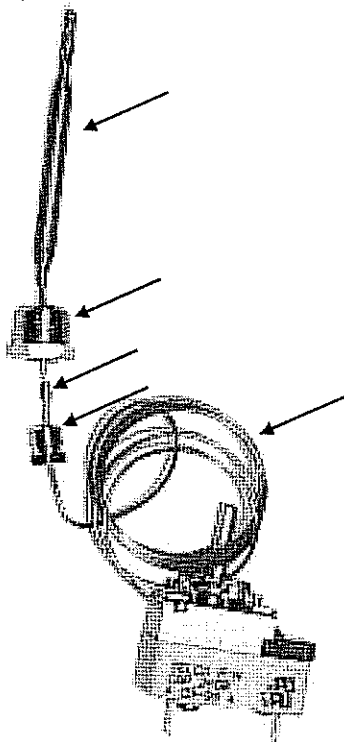
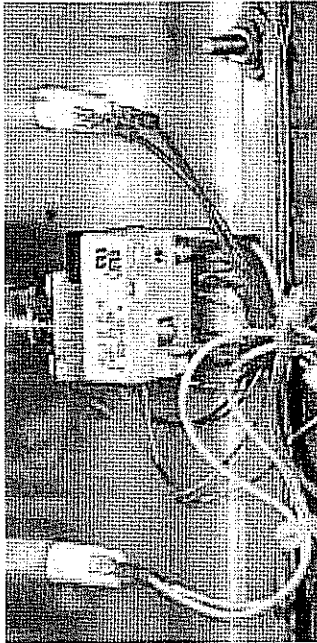

3. Disconnect and mark wire(s) connected to the normally closed and common position on the existing primary thermostat.
4. Drain water in jacket below the thermobulb location.
5. Remove the 3/8" hex pipe plug, which holds the thermobulb in place in the coupling. Pull thermobulb and capillary tube out of the kettle jacket.
6. To remove the existing primary thermostat from the front panel loosen the two mounting screws.
7. Reconnect the wires marked normally closed and common to the new thermostat and secure to front panel with mounting screws.
8. Carefully uncoil the capillary tube (5). Reinsert the thermobulb (1) and two inches of the capillary tube (5) in the coupling from which the existing tube and bulb were removed. **Caution! Do not make any threaded connections before you have the capillary tube and thermobulb in its final position.** Once the thermobulb and capillary tube are in position, you are ready to secure them in place.
9. Coat the outer threads only of the 3/8" hex pipe plug (2) with Teflon pipe sealant. Thread this plug into the coupling securely.
10. Slide the brass ferrule (3) into the recessed center of the 3/8" hex pipe plug (brass ferrule is located on the capillary tube in between the large (2) and small (4) hex pipe plugs).
11. Once the brass ferrule (3) is in place, engage the threads of the small hex pipe plug (4) into the internal threads of the 3/8" hex pipe plug (2) until it stops. **Caution! Do not loosen this connection after it has been tightened, doing so will cause kettle jacket to leak. Do not use Teflon sealant on this connection.**
12. Replace control console panel and secure in place.
13. Refill kettle with pure distilled water. Refer to item 4, Filling Steam Jacket of this section for instructions.

2. Actuator Maintenance and Adjustment

A) Actuator Tension Adjustment

The lid on the LEC and HEC (standard on 60 gallon and up) and TWE (Optional) can operate with spring loaded actuators. If the lid can be raised to any position, and it remains in that position, the actuators are adjusted properly. Should the tension need adjustment after shipping, or at any time in the future, the following procedure can be performed.

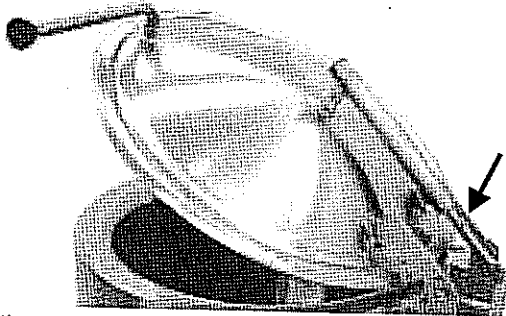

Raise the unit's lid completely. Removal of the stop nut may be needed to raise the lid completely.

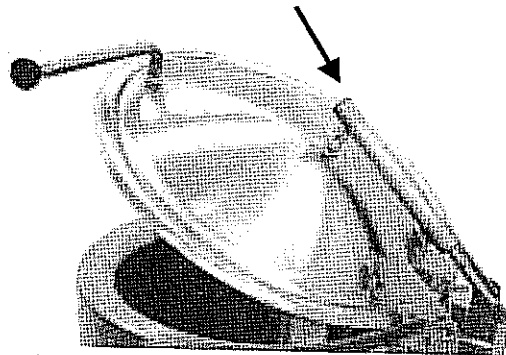

Remove the tube closure cap on the actuator. With a $\frac{3}{4}$ " deep hex socket, turn the adjusting nut (located inside the actuator sleeve) clockwise to increase the tension or counterclockwise to decrease tension. Rotate the nut one turn at a time and test the lid's operation. When the adjustment is complete, replace the tube closure cap on the actuator sleeve.

B) Actuator: Re-Packing With Grease

The lid actuator(s) of your unit must be re-packed with grease every six months to ensure proper operation. Perform the following steps. Refer to *Figure 3.1* and to *Figure 3.2*.

1. Raise the lid of the unit fully.
2. Remove the tube closure cap.
3. Remove the self-locking 1/2-13 hex nut on the actuator rod.
4. If the components inside the actuator sleeve do not slide out easily, remove the bolt, which secures the actuator sleeve to the frame lug. Put aside the bolt, nut, and lock washer for re-assembly later.
5. Grasp the actuator sleeve and pull down away from the actuator rod. The components inside the actuator sleeve will slide out.
6. Pack the spring (or springs) with Bel-Ray No-Tox Clear Grease #2. The grease must be liberally applied between each coil.
7. After re-packing with grease, reassemble the components back inside the actuator sleeve and slide the sleeve back over the actuator rod.
8. Reconnect the actuator assembly to the frame lug using the bolt, nut, and lock washer previously set aside.
9. Adjust the tension of the actuators using the procedure described earlier in this section.

Fig. 3.1: Actuator Components & Assembly

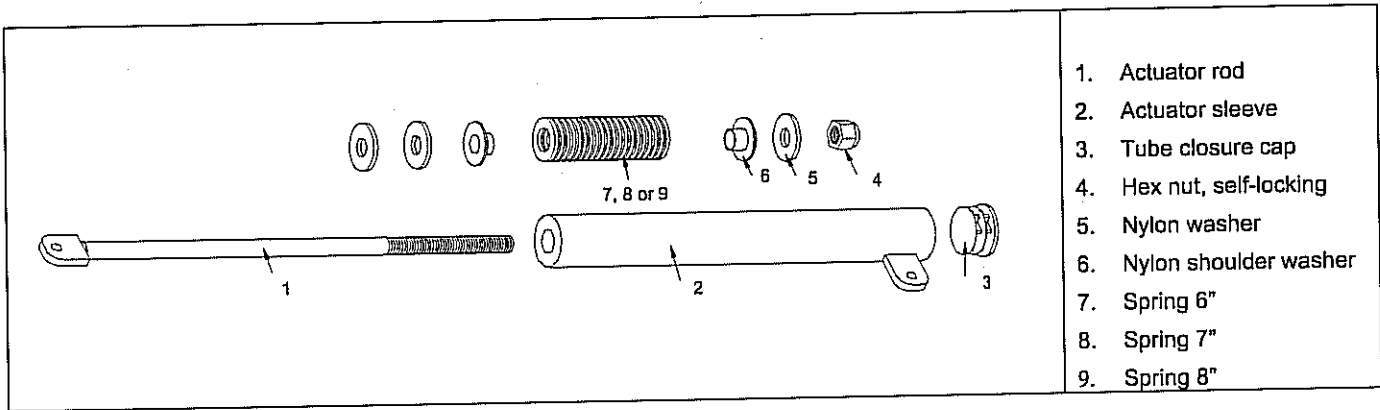

C) Actuator Replacement

Should the actuators on your unit ever require replacement, use the following procedure. Refer to *Figure 3.1* and to *Figure 3.2*.

1. Raise the lid of the unit fully.
2. Remove the tube closure cap.
3. Using a deep socket tool, loosen the self-locking hex nut on the actuator rod (by turning it counterclockwise) to eliminate pressure on the springs.
4. From the *pivot arm* of the actuator, remove the acorn nut, bolt, lock washer, and spacer and retain them for mounting the new actuator(s).
5. From the *frame lug* (at the other end of the actuator) remove the acorn nut, bolt, and lock washer and retain them for mounting the new actuator(s).
6. Mount the new actuators using the bolts, nuts, lock washers, and spacers set-aside in the above steps.
Note: The actuator rod must be free to pivot during use. Therefore, when tightening the hex bolt into the acorn nut, tighten it completely, then back off a half turn.
7. After the new actuator(s) are installed, adjust the tension using the procedure described earlier in this section.

Fig. 3.2: Removing/Installing Actuators

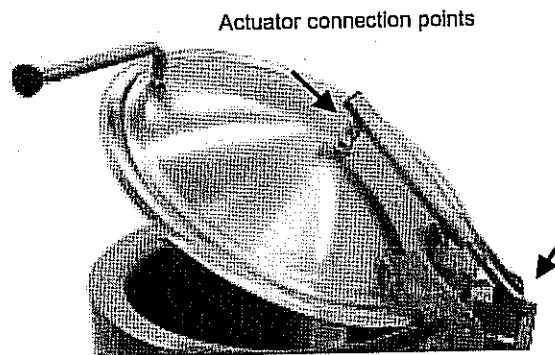

3. Filling Steam Jacket

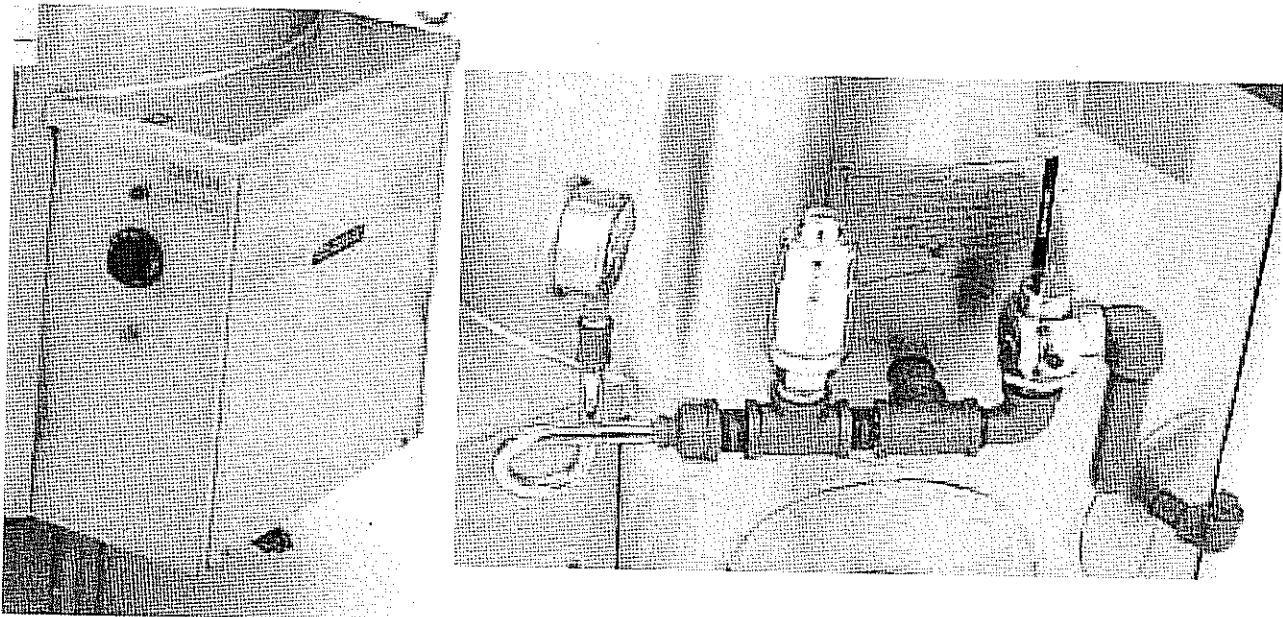

Warning!

After start-up use pure distilled water (free of chlorides) only. Do not use tap water to refill to correct water level. Appliance failure caused by inadequate water quality is not covered under warranty.

Allow kettle to cool. Never attempt to add water to a hot kettle.

Lift the safety valve lever (3) to release any residual steam contained in the steam jacket.

Place the thermostat (1) in the off position. Disconnect power at the customer supplied electrical cut-off device.

Remove pipe plug from inlet elbow (2) and place a funnel in the inlet elbow.

Pour pure distilled water into funnel. Lift safety valve lever to allow air to escape from the jacket. Continue adding water until water in the jacket bubbles out of the inlet elbow. **DO NOT FILL BEYOND THE INLET ELBOW.**

Remove funnel, replace pipe plug in inlet elbow (2) securely and restore power to the kettle.

Caution: Drain the steam jacket if the kettle is to be stored in an unheated area. Water freezing in the steam jacket may cause damage to the unit. Drain is located behind the control-housing panel.

4. Main and Worm Gear (Model TWE Only)

Monthly, check the tilt mechanism (main and worm gear) along with the trunnion support bearings for adequate lubrication. If lubrication is needed, use Bel-Ray No Tox Open Gear Grease or an equivalent edible grease. The tilt mechanism is located in the right-hand console box. Trunnion bearings are located in the left-hand arm and between the right-hand console box and the kettle body.

Section IV: Caring For Stainless Steel

This section provides specific guidelines for cleaning and protecting the stainless steel surface of your equipment.

Important!

Always disconnect power before cleaning (or servicing) the unit. Never spray the control console, electrical controls, gas controls, or connections with water. Clean these areas by wiping them with a clean, damp cloth.

The stainless steel can be cared for using any good commercial stainless steel cleaner or polish. Contrary to popular belief, stainless steel remains resistant to corrosion only as long as its passive surface remains intact. There are some basic rules to prevent the breakdown of this surface.

Only plastic scouring pads and soft cloths should be used, since they will not damage the stainless steel surface. Never use anything that will scratch the surface such as steel pads, wire brushes, or scrapers. In the kettle liner, scratches make cleaning more difficult and provide places for bacteria to collect and grow. Never use steel wool since it can leave particles embedded in the kettle liner and can also lead to eventual corrosion and pitting. Never let deposits from water, particularly hard water, or deposits from food sit on the surface for extended periods. Wipe up deposits and spills promptly. After cleaning, rinse off the cleaning agents thoroughly with water, wipe dry, and then allow the surface to air dry. Oxygen actually helps maintain stainless steel's protective surface.



Never use cleaners containing chlorides (or quaternary salts, since they can also contribute to pitting and rusting). Use only alkaline, alkaline-chlorinated, or non-chloride cleaners.

Tip:

If you've been doing a lot of continued boiling or steaming, you may notice a build-up of lime or scale in the kettle liner. This cleans up easily using vinegar, a vinegar / water mixture, or any commercial de-liming / de-scaling solution.

Section V: Troubleshooting

1. Troubleshooting-General Problems

The Electric Self-Contained Steam Jacketed Kettle is designed to operate smoothly and efficiently if properly maintained. However, in the event of a problem, following is a list of checks to be made by qualified personnel. The wiring diagram for the unit is located behind the removable panel of the control console.

IMPORTANT: Service must be done by a qualified technician experienced with commercial gas and electrical cooking equipment. Use only Legion supplied parts. Unauthorized or generic parts can cause bodily injury and equipment damage. If the unit ever needs repair during the warranty period, prior authorization from Legion is required. Also refer to the sections of this manual entitled *Service Calls* and also *Important Warranty Information*.

SYMPTOM	POSSIBLE CAUSES
Kettle will not heat, indicator light will not come on	Electrical power supply not turned on Loose or broken wires Fuse may be blown in disconnect switch Primary thermostat malfunctioning Automatic low water relay engaged, amber light should be on if this has happened
Kettle continues to heat after it reaches desired temperature	Primary thermostat setting - too high Primary thermostat malfunctioning Contactor possibly de-energized
Kettle does not reach desired temperature	Primary thermostat setting - too low Primary thermostat malfunctioning Check for air in kettle jacket Contactor malfunction
Uneven cooking due to "cold spots"	Heating element - open (burned out) or loose
Rapid clicking noise (chattering)	Supply voltage - possibly too low Contactor - dirt or corrosion on the contacts

Section VI: Parts List

1. General Parts List

PART NO.	ITEM DESCRIPTION
407770-1	Thermostat, primary 150-260°F
407770-1D	Knob, primary thermostat
407793	Grommet thermostat shaft
430083	Pressure limit control (Optional)
460000	Air Eliminator Vent
440168	Safety relief valve 30 psi
400270	Strainer disk 9" compression type with 1/4" holes
400269	Strainer disk 9" compression type with 1/8" holes (Optional)
400271	Strainer disk 9" compression type with solid (Optional)
430032	Low water cut-off relay
430027	Low water relay 8 pin base
440280	Pigtail 1/4" npt BCP
420064	Low water probe 3/8"
406732	Pressure gauge -30 - +100
400780	Fuse block
400781	Fuse 1 amp
406728	Transformer 480 V - 240 V (480 volt models only)
400006	Transformer 380 V - 600 V - 240V (380, 415, 440 volt models only)
407451	Indicator light red 240V
407452	Indicator light amber 240-V
800237	Bullet feet 2"
408693-001	Actuator assembly and hardware 20 & 30 gallon
408693-006	Actuator assembly and hardware 40 - 80 gallon
407977	Kettle care kit 5 - 25 gallon
407978	Kettle care kit 30 - 100 gallon

2. Actuator Parts List & Assembly

Fig. 6.1: Actuator Assembly Diagram

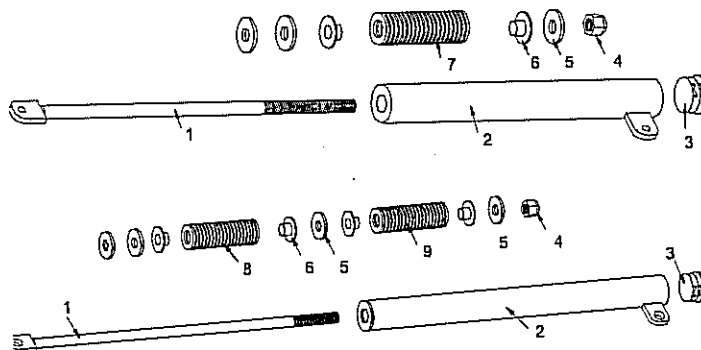

Item No.	Description	Part Number	
		20-30 gallon	40-80 gallon
1	Actuator rod	404481-001	404481-001
2	Actuator sleeve	404483-001	404483-001
3	Tube closure cap	404485	404485
4	Nut, s/s hex 1/2-13 self-locking	405591	405591
5	Nylon washer	408505	408505
6	Nylon shoulder washer	408506	408506
7	Spring, 8" long	408531	N/A
8	Spring, 4.5" long	N/A	404484-11
9	Spring, 6" long	N/A	408173

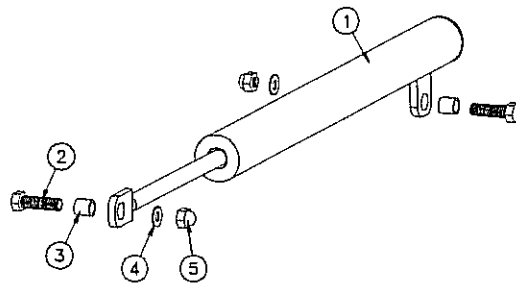

Item No.	Description	Part Number
1	Assembly actuator 20 – 30 gallon kettle	408693-001
1	Assembly actuator 40 – 80 gallon kettle	408693-006
2	Bolt hex head 1/4 - 20 x 7/8" stainless steel	450418
3	Not applicable	N/A
4	Flat washer 1/4" stainless steel	450403
5	Nut, cap 1/4 - 20 BCP	450675

3. Compression Draw-Off Parts List & Assembly

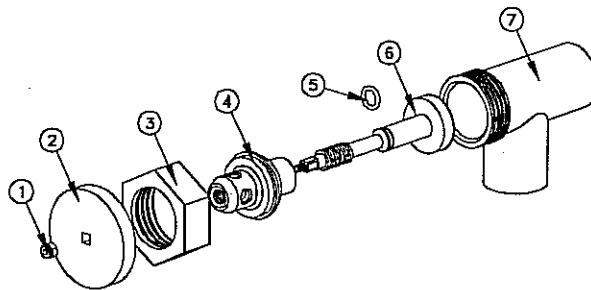

Fig. 6.2: Compression Draw-Off Assembly Diagram

Legion Electric Self-Contained Steam Jacketed Kettle

Item No.	Description	Part Number		
		1 1/2"	2"	3"
1	Nut, handle	408392	408392	408207
2	Handle, round	408359	408359-2	408360
3	Hex bonnet nut	450033-01	450032-01	440234-01
4	Faucet gland	460097-01	410228-01	440233-01
5	"O" ring	400382	400382-2	400382-3
6	Stem with viton coating	440131-01RV	440058-01RV	400346-01RV
	Compression draw-off valve (complete)	405932	405932-2	405995

4. Electrical Data Table

Model	Volts	Phase	KW/Unit	Amp	Fuse		Resistance	Contactor		Heater		Indicator Light PN		Dist. Block PN	Wire Size
					Size"	Heater		Qty	Part No.	Qty	Part No.	Red	Amber		
LEC-20	208	1	9.0	43.3	50	9.0	4.81	1	406567	1	400340	407451	407452	407726	8
	240	1	9.0	37.5	40	9.0	6.40	1	420083	1	820432	407451	407452	407726	10
	380	1	9.0	23.7	40	9.0	16.04	1	420083	1	408861-380	407451	407452	407726	12
	415	1	9.0	21.7	40	9.0	19.14	1	420083	1	408861-415	407451	407452	407726	14
	440	1	9.0	20.5	40	9.0	21.51	1	420083	1	408861-440	407451	407452	407726	14
	480	1	9.0	18.8	40	9.0	25.60	1	420083	1	820480	407451	407452	407726	14
	208	3	9.0	25.0	40	9.0	8.33	1	420083	1	400340	407451	407452	407726	12
	240	3	9.0	21.7	40	9.0	11.08	1	420083	1	820432	407451	407452	407726	14
	380	3	9.0	13.7	40	9.0	27.79	1	420083	1	408861-380	407451	407452	407726	14
	415	3	9.0	12.5	40	9.0	33.14	1	420083	1	408861-415	407451	407452	407726	14
	440	3	9.0	11.8	40	9.0	37.26	1	420083	1	408861-440	407451	407452	407726	14
	480	3	9.0	10.8	40	9.0	44.34	1	420083	1	820480	407451	407452	407726	14
LEC-30	208	1	12.0	57.7	60	12.0	3.61	1	420084	1	408862-208	407451	407452	407726	8
	240	1	12.0	50.0	60	12.0	4.80	1	420084	1	820433	407451	407452	407726	8
	380	1	12.0	31.6	40	12.0	12.03	1	420083	1		407451	407452	407726	10
	415	1	12.0	28.9	40	12.0	14.35	1	420083	1	408862-415	407451	407452	407726	12
	440	1	12.0	27.3	40	12.0	16.13	1	420083	1	408862-440	407451	407452	407726	12
	480	1	12.0	25.0	40	12.0	19.20	1	420083	1	820482	407451	407452	407726	12
	208	3	12.0	33.3	40	12.0	6.24	1	420083	1	408862-208	407451	407452	407726	10
	240	3	12.0	28.9	40	12.0	8.31	1	420083	1	820433	407451	407452	407726	12
	380	3	12.0	18.2	40	12.0	20.84	1	420083	1		407451	407452	407726	14
	415	3	12.0	16.7	40	12.0	24.86	1	420083	1	408862-415	407451	407452	407726	14
	440	3	12.0	15.7	40	12.0	27.94	1	420083	1	408862-440	407451	407452	407726	14
	480	3	12.0	14.4	40	12.0	33.25	1	420083	1	820482	407451	407452	407726	14
LEC-40	208	1	15.0	72.1	75	15.0	2.88	1	406570	1	820481	407451	407452	407726	6
	240	1	15.0	62.5	75	15.0	3.84	1	406570	1	820431	407451	407452	407726	6
	380	1	15.0	39.5	40	15.0	9.63	1	420083	1	820434	407451	407452	407726	10
	415	1	15.0	36.1	40	15.0	11.48	1	420083	1	408863-415	407451	407452	407726	10
	440	1	15.0	34.1	40	15.0	12.91	1	420083	1	408863-440	407451	407452	407726	10
	480	1	15.0	31.3	40	15.0	15.36	1	420083	1	820483	407451	407452	407726	10
	208	3	15.0	41.6	50	15.0	5.00	1	406567	1	820481	407451	407452	407726	8
	240	3	15.0	36.1	40	15.0	6.65	1	420083	1	820431	407451	407452	407726	10
	380	3	15.0	22.8	40	15.0	16.67	1	420083	1	820434	407451	407452	407726	14
	415	3	15.0	20.9	40	15.0	19.89	1	420083	1	408863-415	407451	407452	407726	14
	440	3	15.0	19.7	40	15.0	22.35	1	420083	1	408863-440	407451	407452	407726	14
	480	3	15.0	18.0	40	15.0	26.60	1	420083	1	820483	407451	407452	407726	14

Legion Electric Self-Contained Steam Jacketed Kettle

Model	Volts	Phase	KW/Unit	Amp	Fuse		Resistance	Contactor		Heater		Indicator Light PN		Dist. Block PN	Wire Size	
					Size*	Heater		Qty	Part No.	Qty	Part No.	Red	Amber			
LEC-60	208	1	24.0	115.4	60	12.0	3.61	2	420084	2	408862-208	407451	407452	407726	8	
	240	1	24.0	100.0	60	12.0	4.80	2	420084	2	820433	407451	407452	407726	8	
	380	1	24.0	63.2	75	12.0	12.03	1	406570	2		407451	407452	407726	6	
	415	1	24.0	57.8	60	12.0	14.35	1	420084	2	408862-415	407451	407452	407726	8	
	440	1	24.0	54.5	60	12.0	16.13	1	420084	2	408862-440	407451	407452	407726	8	
	480	1	24.0	50.0	60	12.0	19.20	1	420084	2	820482	407451	407452	407726	8	
	208	3	24.0	66.6	75	12.0	6.24	1	406570	2	408862-208	407451	407452	407726	6	
	240	3	24.0	57.7	60	12.0	8.31	1	420084	2	820433	407451	407452	407726	8	
	380	3	24.0	36.5	40	12.0	20.84	1	420083	2		407451	407452	407726	10	
	415	3	24.0	33.4	40	12.0	24.86	1	420083	2	408862-415	407451	407452	407726	10	
	440	3	24.0	31.5	40	12.0	27.94	1	420083	2	408862-440	407451	407452	407726	10	
	480	3	24.0	28.9	40	12.0	33.25	1	420083	2	820482	407451	407452	407726	12	
	LEC-80	208	1	30.0	144.2	75	15.0	2.88	2	406570	2	820481	407451	407452	407726	6
		240	1	30.0	125.0	75	15.0	3.84	2	406570	2	820431	407451	407452	407726	6
380		1	30.0	78.9	90	15.0	9.63	1	406571	2	820434	407451	407452	407726	6	
415		1	30.0	72.3	75	15.0	11.48	1	406570	2	408863-415	407451	407452	407726	6	
440		1	30.0	68.2	75	15.0	12.91	1	406570	2	408863-440	407451	407452	407726	6	
480		1	30.0	62.5	75	15.0	15.36	1	406570	2	820483	407451	407452	407726	6	
208		3	30.0	83.3	90	15.0	5.00	1	406571	2	820481	407451	407452	407726	6	
240		3	30.0	72.2	75	15.0	6.65	1	406570	2	820431	407451	407452	407726	6	
380		3	30.0	45.6	50	15.0	16.67	1	406567	2	820434	407451	407452	407726	8	
415		3	30.0	41.7	50	15.0	19.89	1	406567	2	408863-415	407451	407452	407726	8	
440		3	30.0	39.4	40	15.0	22.35	1	420083	2	408863-440	407451	407452	407726	10	
480		3	30.0	36.1	40	15.0	26.60	1	420083	2	820483	407451	407452	407726	10	
HEC-20 or TWE-20		208	1	12.0	57.7	60	12.0	3.61	1	420084	1	408862-208	407451	407452	407726	8
		240	1	12.0	50.0	60	12.0	4.80	1	420084	1	820433	407451	407452	407726	8
	380	1	12.0	31.6	40	12.0	12.03	1	420083	1		407451	407452	407726	10	
	415	1	12.0	28.9	40	12.0	14.35	1	420083	1	408862-415	407451	407452	407726	12	
	440	1	12.0	27.3	40	12.0	16.13	1	420083	1	408862-440	407451	407452	407726	12	
	480	1	12.0	25.0	40	12.0	19.20	1	420083	1	820482	407451	407452	407726	12	
	208	3	12.0	33.3	40	12.0	6.24	1	420083	1	408862-208	407451	407452	407726	10	
	240	3	12.0	28.9	40	12.0	8.31	1	420083	1	820433	407451	407452	407726	12	
	380	3	12.0	18.2	40	12.0	20.84	1	420083	1		407451	407452	407726	14	
	415	3	12.0	16.7	40	12.0	24.86	1	420083	1	408862-415	407451	407452	407726	14	
	440	3	12.0	15.7	40	12.0	27.94	1	420083	1	408862-440	407451	407452	407726	14	
	480	3	12.0	14.4	40	12.0	33.25	1	420083	1	820482	407451	407452	407726	14	
	HEC-30 or TWE-30	208	1	24.0	115.4	60	12.0	3.61	2	420084	2	408862-208	407451	407452	407726	8
		240	1	24.0	100.0	60	12.0	4.80	2	420084	2	820433	407451	407452	407726	8
380		1	24.0	63.2	75	12.0	12.03	1	406570	2		407451	407452	407726	6	
415		1	24.0	57.8	60	12.0	14.35	1	420084	2	408862-415	407451	407452	407726	8	
440		1	24.0	54.5	60	12.0	16.13	1	420084	2	408862-440	407451	407452	407726	8	
480		1	24.0	50.0	60	12.0	19.20	1	420084	2	820482	407451	407452	407726	8	
208		3	24.0	66.6	75	12.0	6.24	1	406570	2	408862-208	407451	407452	407726	6	
240		3	24.0	57.7	60	12.0	8.31	1	420084	2	820433	407451	407452	407726	8	
380		3	24.0	36.5	40	12.0	20.84	1	420083	2		407451	407452	407726	10	
415		3	24.0	33.4	40	12.0	24.86	1	420083	2	408862-415	407451	407452	407726	10	
440		3	24.0	31.5	40	12.0	27.94	1	420083	2	408862-440	407451	407452	407726	10	
480		3	24.0	28.9	40	12.0	33.25	1	420083	2	820482	407451	407452	407726	12	
HEC-40 or		208	1	24.0	115.4	60	12.0	3.61	2	420084	2	408862-208	407451	407452	407726	8

Legion Electric Self-Contained Steam Jacketed Kettle

Model	Volts	Phase	KW/Unit	Amp	Fuse	KW	Contactor		Heater		Indicator Light PN		Dist.	Wire	
					Size*	Heater	Resistance	Qty	Part No.	Qty	Part No.	Red	Amber	Block PN	Size
TWE-40	240	1	24.0	100.0	60	12.0	4.80	2	420084	2	820433	407451	407452	407726	8
	380	1	24.0	63.2	75	12.0	12.03	1	406570	2		407451	407452	407726	6
	415	1	24.0	57.8	60	12.0	14.35	1	420084	2	408862-415	407451	407452	407726	8
	440	1	24.0	54.5	60	12.0	16.13	1	420084	2	408862-440	407451	407452	407726	8
	480	1	24.0	50.0	60	12.0	19.20	1	420084	2	820482	407451	407452	407726	8
	208	3	24.0	86.6	75	12.0	6.24	1	406570	2	408862-208	407451	407452	407726	6
	240	3	24.0	57.7	60	12.0	8.31	1	420084	2	820433	407451	407452	407726	8
	380	3	24.0	36.5	40	12.0	20.84	1	420083	2		407451	407452	407726	10
	415	3	24.0	33.4	40	12.0	24.86	1	420083	2	408862-415	407451	407452	407726	10
	440	3	24.0	31.5	40	12.0	27.94	1	420083	2	408862-440	407451	407452	407726	10
	480	3	24.0	28.9	40	12.0	33.25	1	420083	2	820482	407451	407452	407726	12
	HEC-60 or TWE-60	208	1	36.0	173.1	60	12.0	3.61	3	420084	3	408862-208	407451	407452	407726
	240	1	36.0	150.0	60	12.0	4.80	3	420084	3	820433	407451	407452	407726	8
	380	1	36.0	94.7	40	12.0	12.03	3	420083	3		407451	407452	407726	10
	415	1	36.0	86.7	90	12.0	14.35	1	406571	3	408862-415	407451	407452	407726	6
	440	1	36.0	81.8	90	12.0	16.13	1	406571	3	408862-440	407451	407452	407726	6
	480	1	36.0	75.0	90	12.0	19.20	1	406571	3	820482	407451	407452	407726	6
	208	3	36.0	99.9	40	12.0	6.24	1	420083	3	408862-208	407451	407452	407726	10
	240	3	36.0	86.6	90	12.0	8.31	1	406571	3	820433	407451	407452	407726	6
	380	3	36.0	54.7	60	12.0	20.84	1	420084	3		407451	407452	407726	8
	415	3	36.0	50.1	60	12.0	24.86	1	420084	3	408862-415	407451	407452	407726	8
	440	3	36.0	47.2	50	12.0	27.94	1	406567	3	408862-440	407451	407452	407726	8
	480	3	36.0	43.3	50	12.0	33.25	1	406567	3	820482	407451	407452	407726	8
HEC-80	208	1	36.0	173.1	60	12.0	3.61	3	420084	3	408862-208	407451	407452	407726	8
	240	1	36.0	150.0	60	12.0	4.80	3	420084	3	820433	407451	407452	407726	8
	380	1	36.0	94.7	40	12.0	12.03	3	420083	3		407451	407452	407726	10
	415	1	36.0	86.7	90	12.0	14.35	1	406571	3	408862-415	407451	407452	407726	6
	440	1	36.0	81.8	90	12.0	16.13	1	406571	3	408862-440	407451	407452	407726	6
	480	1	36.0	75.0	90	12.0	19.20	1	406571	3	820482	407451	407452	407726	6
	208	3	36.0	99.9	40	12.0	6.24	3	420083	3	408862-208	407451	407452	407726	10
	240	3	36.0	86.6	90	12.0	8.31	1	406571	3	820433	407451	407452	407726	6
	380	3	36.0	54.7	60	12.0	20.84	1	420084	3		407451	407452	407726	8
	415	3	36.0	50.1	60	12.0	24.86	1	420084	3	408862-415	407451	407452	407726	8
	440	3	36.0	47.2	50	12.0	27.94	1	406567	3	408862-440	407451	407452	407726	8
	480	3	36.0	43.3	50	12.0	33.25	1	406567	3	820482	407451	407452	407726	8

*Recommended fuse size for overcurrent protection. See Section I, Item 3.

For Your Use & Review

Installation Checklist

Proper operation of the Legion Electric Self-Contained Steam Jacketed Kettle is dependent upon proper installation. Performing the following checks at the time of installation could avoid unnecessary service calls.

IMPORTANT: Recording the following information is necessary for your warranty to be valid.

<i>Item</i>	<i>Reference Section</i>	<i>Verify Completion</i>
1. Verify that specified clearances are met.	Installation 1. Positioning the Unit	_____
2. Verify that ventilation hood requirements comply with all code requirements. It is the responsibility of the owner and/or installer to learn and comply with these codes.		_____
3. Verify the voltage requirements and electrical connections were checked. Note the incoming power supply range cannot exceed plus or minus 5 percent of the unit's voltage rating.	Installation 3. Electrical Connection	_____
4. Verify the fused disconnect switch installed between main power supply and unit. Refer to Section VI, Item 4, Electrical Data Table for recommended fuse size.	Installation 3. Electrical Connection	_____
5. Verify that actuators are adjusted to hold cover in proper position.	Service and Maintenance 2. Actuator Maintenance and Adjustment	_____

Legion Limited Warranty and Extended Warranty Coverage

To COMMERCIAL PURCHASERS 02/01* (Domestic U.S. Sales Only)

Legion equipment has been skillfully designed and manufactured, carefully inspected and packaged to meet rigid standards of excellence and is warranted to be free from defects in material and workmanship subject to the following limitations.

Users	This warranty is limited to Legion equipment sold to the original commercial user (but not original equipment manufacturers), at the original place of installation, in the continental United States and Hawaii. Equipment must be registered within ten (10) days of installation. Damage incurred during shipment is to be reported to the carrier, and is not covered under this warranty.
Warranty Time Period	This warranty is valid for twelve (12) months from installation (See "Users" regarding registration) or fifteen (15) months from ship date, whichever occurs first.
Time Period	Exceptions to standard warranty period are as follows: These parts will be covered for a period of 90 days from registration.
Exceptions	<ul style="list-style-type: none"> • Draw-off valve stems • Water fill faucets and spray heads • Teflon packing • Switches • Indicator lights • Valve stem packing and seats • Sight glasses • Timers
Installation	<p>Proper installation and installation verification is the responsibility of the owner-user and is not covered by this warranty. Many local codes exist, and it is the responsibility of the owner and installer to comply with these codes. Legion equipment is built to comply with applicable standards for manufacturers. Included among these approval agencies are: UL, NSF, ASME/National Board, CSA, AGA, CGA, ETL and others. Our program of constant product improvement makes it necessary for new or improved models to be submitted for testing by these various agencies as they are developed. Therefore, not all models bear the appropriate agency approval or certification at all times.</p> <p>Adjustments such as leveling, tightening of fasteners or utility connections (gas, electric, steam or water) normally associated with original installation are the responsibility of the owner-user or installer.</p>
Authorized Agency	Legion will replace or repair at no cost, F.O.B. plant of manufacture, any part of all equipment, which becomes defective due to material or factory workmanship within the warranty period. Legion agrees to pay for normal service rates required to repair or replace, at our option any part which proves to be defective in material or workmanship, during the labor warranty period. This warranty includes travel time not to exceed lesser of two (2) hours round-trip and mileage not to exceed 50 miles (150 miles round-trip).
Replacement Parts	Warranty on all replacement parts which are replaced in the field by Legion Authorized Service Agencies will be limited to three (3) months on labor, six (6) months on materials (parts) effective from the date of installation.
Specific Exclusions	<ul style="list-style-type: none"> • Freight damage. • Failure as a result of improper use or abuse of equipment. • Equipment not properly registered within ten (10) days of installation. • Equipment failure relating to improper installation. Examples are but not limited to: Improper utility connection(s), improper utilities supply and problems due to ventilation. • Equipment that has been modified, changed, or altered from its original shipped configuration, failure to use factory approved OEM replacement parts. • Use of other than pure distilled water (free of chlorides) in self-contained kettles. • Water damage to controls (electrical and mechanical) and other surfaces. • Equipment that has not been properly maintained. Examples are but not limited to: adjustments to pilots and burners and damage from improper cleaning. • Labor involved in moving adjacent objects to gain access to the equipment. • Expendable parts such as bulbs, gaskets, washers, plastic knobs & handles, bag filters, scraper blades, fuses, vinyl spray hoses, cleaning brushes and care kits. • Tampering, changing or adjusting any control equipment which was permanently set by the factory. • Use of materials containing components harmful to stainless steel. • Changes, alterations, or modifications to equipment or parts by the owner, user, installer or any third party.
Claims Procedure	Claims of defects must be asserted by customer by written notice, accompanied by a description of the defect, proof of purchase, the delivery date and the date of installation, to Legion within ten (10) days after the defect is discovered but in no event beyond the applicable warranty time period. All claims under the Limited Warranty provided herein which are not made in accordance with the claims procedure set forth herein, are deemed waived and released by the customer. Following its receipt of such a claim, Legion will notify customer whether customer must ship the defective part, freight prepaid, to Legion for repair or replacement, or whether repair or replacement will be accomplished on customer's premises.
Limitations	<p>THE FOREGOING SHALL CONSTITUTE THE SOLE AND EXCLUSIVE REMEDY OF ORIGINAL PURCHASER AND THE FULL LIABILITY OF LEGION INDUSTRIES FOR ANY BREACH OF WARRANTY. THE FOREGOING IS EXCLUSIVE AND IN LIEU OF ALL OTHER WARRANTIES, WHETHER WRITTEN, ORAL OR IMPLIED, INCLUDING ANY WARRANTY OF PERFORMANCE, MERCHANTABILITY, OR FITNESS FOR A PARTICULAR PURPOSE OR USE, AND SUPERSEDES AND EXCLUDES ANY ORAL OR OTHER WRITTEN WARRANTIES OR REPRESENTATIONS, NOT EXPRESSLY DESIGNATED IN WRITING AS A "WARRANTY" OR "GUARANTEE" OF LEGION INDUSTRIES MADE OR IMPLIED IN ANY MANUAL, LITERATURE, ADVERTISING BROCHURE OR OTHER MATERIALS OR MADE BY EMPLOYEES OR AGENTS OF LEGION.</p> <p>LEGION'S LIABILITY ON ANY CLAIM OF ANY KIND, INCLUDING NEGLIGENCE, WITH RESPECT TO THE GOODS OR SERVICES COVERED HEREUNDER, SHALL IN NO CASE EXCEED THE PRICE OF THE GOODS OR SERVICES, OR PART THEREOF, WHICH GIVES RISE TO THE CLAIM. IN NO EVENT SHALL LEGION INDUSTRIES BE LIABLE FOR SPECIAL, INCIDENTAL, OR CONSEQUENTIAL DAMAGES, OR ANY DAMAGES IN THE NATURE OF PENALTIES.</p>
Limited Extended Warranty Coverage	<p>The purchaser of a Limited Extended Warranty Contract extends the standard warranty coverage to the purchased period of time (one to two years) from the date of registration or date of shipment, whichever is sooner. An additional two years Parts and Labor Warranty can be purchased with each piece of Legion equipment for an additional 3% of the List Price per year. The 3% of list price charge will be the net invoice amount for each year of extended warranty purchased.</p> <ul style="list-style-type: none"> § Extended warranty must be purchased at the same time the equipment is purchased. § Extended Warranty has the same exclusions as stated in our standard warranty.

Legion Limited Warranty and Extended Warranty Coverage - Canada

To COMMERCIAL PURCHASERS 02/01*
(Canada Sales Only)

Legion equipment has been skillfully designed and manufactured, carefully inspected and packaged to meet rigid standards of excellence and is warranted to be free from defects in material and workmanship subject to the following limitations.

Users	This warranty is limited to Legion equipment sold to the original commercial user (but not original equipment manufacturers), at the original place of installation, in Canada. Equipment must be registered within ten (10) days of installation. Damage incurred during shipment is to be reported to the carrier, and is not covered under this warranty.
Warranty Time Period	This warranty is valid for twelve (12) months from installation (See "Users" regarding registration) or fifteen (15) months from ship date, whichever occurs first.
Time Period	Exceptions to standard warranty period are as follows: These parts will be covered for a period of 90 days from registration.
Exceptions	<ul style="list-style-type: none"> • Draw-off valve stems • Water fill faucets and spray heads • Teflon packing • Switches • Indicator lights • Valve stem packing and seats • Slight glasses • Timers
Installation	<p>Proper installation and installation verification is the responsibility of the owner-user and is not covered by this warranty. Many local codes exist, and it is the responsibility of the owner and installer to comply with these codes. Legion equipment is built to comply with applicable standards for manufacturers. Included among these approval agencies are: UL, NSF, ASME/National Board, CSA, AGA, CGA, ETL and others. Our program of constant product improvement makes it necessary for new or improved models to be submitted for testing by these various agencies as they are developed. Therefore, not all models bear the appropriate agency approval or certification at all times.</p> <p>Adjustments such as leveling, tightening of fasteners or utility connections (gas, electric, steam or water) normally associated with original installation are the responsibility of the owner-user or installer.</p>
Authorized Agency	Legion will replace or repair at no cost, F.O.B. plant of manufacture, any part of all equipment, which becomes defective due to material or factory workmanship within the warranty period. Legion agrees to pay for normal service rates required to repair or replace, at our option any part which proves to be defective in material or workmanship, during the labor warranty period. This warranty includes travel time not to exceed lesser of two (2) hours round-trip and mileage not to exceed 50 miles (150 miles round-trip).
Replacement Parts	Warranty on all replacement parts which are replaced in the field by Legion Authorized Service Agencies will be limited to three (3) months on labor, six (6) months on materials (parts) effective from the date of installation.
Specific Exclusions	<ul style="list-style-type: none"> • Freight damage. • Failure as a result of improper use or abuse of equipment. • Equipment not properly registered within ten (10) days of installation. • Equipment failure relating to improper installation. Examples are but not limited to: improper utility connection(s), improper utilities supply and problems due to ventilation. • Equipment that has been modified, changed, or altered from its original shipped configuration, failure to use factory approved OEM replacement parts. • Use of other than pure distilled water (free of chlorides) in self-contained kettles. • Water damage to controls (electrical and mechanical) and other surfaces. • Equipment that has not been properly maintained. Examples are but not limited to: adjustments to pilots and burners and damage from improper cleaning. • Labor involved in moving adjacent objects to gain access to the equipment. • Expendable parts such as bulbs, gaskets, washers, plastic knobs & handles, bag filters, scraper blades, fuses, vinyl spray hoses, cleaning brushes and care kits. • Tampering, changing or adjusting any control equipment which was permanently set by the factory. • Use of materials containing components harmful to stainless steel. • Changes, alterations, or modifications to equipment or parts by the owner, user, installer or any third party.
Claims Procedure	Claims of defects must be asserted by customer by written notice, accompanied by a description of the defect, proof of purchase, the delivery date and the date of installation, to Legion within ten (10) days after the defect is discovered but in no event beyond the applicable warranty time period. All claims under the Limited Warranty provided herein which are not made in accordance with the claims procedure set forth herein, are deemed waived and released by the customer. Following its receipt of such a claim, Legion will notify customer whether customer must ship the defective part, freight prepaid, to Legion for repair or replacement, or whether repair or replacement will be accomplished on customer's premises.
Limitations	<p>THE FOREGOING SHALL CONSTITUTE THE SOLE AND EXCLUSIVE REMEDY OF ORIGINAL PURCHASER AND THE FULL LIABILITY OF LEGION INDUSTRIES FOR ANY BREACH OF WARRANTY. THE FOREGOING IS EXCLUSIVE AND IN LIEU OF ALL OTHER WARRANTIES, WHETHER WRITTEN, ORAL OR IMPLIED, INCLUDING ANY WARRANTY OF PERFORMANCE, MERCHANTABILITY, OR FITNESS FOR A PARTICULAR PURPOSE OR USE, AND SUPERSEDES AND EXCLUDES ANY ORAL OR OTHER WRITTEN WARRANTIES OR REPRESENTATIONS, NOT EXPRESSLY DESIGNATED IN WRITING AS A "WARRANTY" OR "GUARANTEE" OF LEGION INDUSTRIES MADE OR IMPLIED IN ANY MANUAL, LITERATURE, ADVERTISING BROCHURE OR OTHER MATERIALS OR MADE BY EMPLOYEES OR AGENTS OF LEGION.</p> <p>LEGION'S LIABILITY ON ANY CLAIM OF ANY KIND, INCLUDING NEGLIGENCE, WITH RESPECT TO THE GOODS OR SERVICES COVERED HEREUNDER, SHALL IN NO CASE EXCEED THE PRICE OF THE GOODS OR SERVICES, OR PART THEREOF, WHICH GIVES RISE TO THE CLAIM. IN NO EVENT SHALL LEGION INDUSTRIES BE LIABLE FOR SPECIAL, INCIDENTAL, OR CONSEQUENTIAL DAMAGES, OR ANY DAMAGES IN THE NATURE OF PENALTIES.</p>
Limited Extended Warranty Coverage	<p>The purchaser of a Limited Extended Warranty Contract extends the standard warranty coverage to the purchased period of time (one to two years) from the date of registration or date of shipment, whichever is sooner. An additional two years Parts and Labor Warranty can be purchased with each piece of Legion equipment for an additional 6% of the List Price per year. The 6% of list price charge will be the net invoice amount for each year of extended warranty purchased.</p> <ul style="list-style-type: none"> § Extended warranty must be purchased at the same time the equipment is purchased. § Extended Warranty has the same exclusions as stated in our standard warranty.