

Operations & Service Manual

CF-400G



Giles Enterprises, Inc.

An ISO9001 Registered Company

2750 Gunter Park Drive West • Montgomery, AL 36109 USA

Fax: (334) 272-3561 • Internet: www.gilesent.com

Service Hotline (Toll Free): 1-800-554-4537 (USA & Canada Only)

Form No. 60201 (Revised 01/04/07)

Safety



FOR YOUR SAFETY

! ***DO NOT store or use gasoline or use gasoline or other flammable vapors and liquids in the vicinity of this or any other appliance!***

! **WARNING**

Improper installation, adjustment, alteration, service or maintenance can cause property damage, injury or death. Read the installation, operating, and maintenance instructions thoroughly before installing or servicing this equipment.

POST IN A PROMINENT LOCATION instructions to be followed in the event the user smells gas. This information shall be obtained by consulting the local gas supplier.



I	Introduction	2
1	Installation	
1 - 1	Installation Instructions	3
1 - 2	Removal of Fryer From Crate	7
1 - 3	Ventilation of Fryer	7
1 - 4	Electrical Requirements	7
2	Operating Instructions	8
3	Fryer Components and Their Functions	
3 - 1	Control Panel	11
3 - 2	Lower Cabinet Area	12
3 - 3	Cooking Vessel	14
3 - 4	Cooking Computer Features	16
3 - 5	Cooking Computer Function Keys	17
3 - 6	Cooking Computer Programming	18
4	Testing the Fryer	
4 - 1	Proper Control Settings for Check-Out	20
4 - 2	Operational Check of Burner System	20
4 - 3	Operational Check-Out of the Filter Pump	21
5	Preparing the Fryer for Operation	
5 - 1	Fryer Boil-Out Procedure	22
5 - 2	Cleaning of Filter Pan / Replacement of Filter Pan	27
5 - 5	Operating Fryer Controls for Cooking	29
5 - 6	Filtering the Fryer	30

Table of Contents

Model: CF-400G



6	Troubleshooting	
6-1	Temperature Control System	31
6-2	Automatic Basket Lift and Oil Filtration System	32
7	Parts	
7-1	Front Control Panel	34
7-2	Rear View of Lower Cabinet	35
7-3	Rear View of Header Section	36
7-5	Filter Pan Assembly	37
8	Wiring Diagrams	
8-1	Model CF-400G 208/240/60/1	38
8-2	Model CF-400G 208/240/60/1	40
8-3	Model CF-400G 220/50/1 or 240/50/2	42
8-4	Model CF-400G 120/60/1	44

Introduction



Congratulations on the purchase of your new Giles Gas Fryer. The Giles Model CF-400G fryer is equipped with a high quality Cooking Computer. This new “User friendly” easily programmable Cooking Computer incorporates extensive design detail by its manufacture WATLOW, and extensive cooking application by the “Giles” engineering team. The new cooking computer along with the Giles fryer is truly a “world class” product.

To help protect your investment in this state-of-the-art cooking equipment, we recommend you take a few moments to familiarize yourself with the installation, cleaning and maintenance procedures contained in this manual. Adherence to these recommended procedures minimizes the potential for costly “Down-Time” and equipment repairs.

Parts Ordering and Service Information

If you require repair or assistance, please contact your local independent distributor. If you require further assistance please contact our corporate office in Montgomery, Alabama at 1-800-554-4537.

Please have the following information available when calling for assistance. It may be helpful to record this information in the blanks provided below for a quick reference.

1. Model Number: _____
2. Serial Number: _____
3. Gas Type (L.P or Nat.): _____
4. Voltage: _____
5. Nature of Problem: _____

Installation

1 - 1 Installation Instructions

This section provides a summary of the procedures necessary for proper installation of your new Giles Gas Fryer. To prevent personal injury or equipment damage, please ensure the following steps are taken:



For Your Safety do not store or use gasoline or other flammable vapors and liquids in the vicinity of this or any other appliance!

1. **POST IN A PROMINENT LOCATION instructions to be followed in the event the user smells gas. This information can be obtained by consulting your local gas supplier.**
2. Keep the appliance and surrounding area free and clear from combustible materials:

For CF-400G allow a minimum clearance from combustible oil construction of 4" (10.2cm) from bottom, side and back of the Fryer.
3. Do not obstruct the flow of combustion and ventilation of air.
4. Please retain this manual for future reference.
5. Please note wiring diagrams for this appliance are located in the rear of the manual. Ensure the wiring diagram which you consult corresponds to the model being operated.
6. The installation must conform with local codes or, in the absence of local codes, with National Fuel Gas Code ANSI Z223.1 - 1988. When in Canada, installation must be in accordance with CN 1-B149.1 or .2 . Installation must also conform with ANSI/NFPA 96.
7. The Fryer and its individual shutoff valve must be disconnected from the gas piping system during any pressure testing of that system at test pressure in excess of 1/4 psig (3.45 kPa).
8. The Fryer must be isolated from the gas supply piping system by closing its individual manual shutoff valve during any pressure testing of the gas supply piping system at test pressures equal to or less than 1/4 psig (3.45 kPa), (14" water column).



CAUTION

The flue gases of this appliance must be vented to the outside in accordance with National Fuel Gas Code, ANSI Z223.1-1988 and terminate in a UL listed outside vent terminal. When in Canada reference CANI-B149.1 or .2 "Installation Codes for Gas Burning Appliances and Equipment".

9. Please ensure this appliance is electrically grounded in accordance with local codes, or in the absence of local codes, with the National Electrical Code, ANSI/NFPA 70 - 1990. When in Canada reference CSA C22-1 "Canadian Electrical Code Part 1".
10. Please provide adequate room for servicing and proper operation of this appliance. Also, provide adequate ventilation in the operating area where necessary.

Installation

- 
11. Make sure the Gas Connector complies with Standard for Movable Gas Appliance, ANSI, 69-1987 and Addenda Z21.69-1989 (in Canada CANI-6-10-88), and the quick disconnect device complies with the Standard for Quick-Disconnect Devices for Use with Gas Fuel, ANSI Z21.41-1989, (in Canada CANI 6.9 M79). Adequate means must be provided to limit the movement of the fryer. A ring which is located on the lower right hand side of the fryers back is to be used for the attachment of a restraining devise.
 12. Please provide for adequate air intake into combustion chamber.
 13. Always consult with an electrician or other individual prior to installation.
 14. Ensure voltage, amperage, and gas type (PROPANE OR NATURAL GAS ONLY) supplied to the unit are as specified on the fryer's rating plate.

IMPORTANT NOTE

The wrong Fuel Source can damage the Fryer Unit and void the warranty.

15. To avoid the splashing of hot liquid make sure this unit is in a secure position such as connected to a battery of appliances or adequately tied and will not move or tip. Locking casters are supplied on this unit—use them!
17. This appliance is to be installed, used and maintained in accordance with the Standard for Ventilation Control, and Fire Protection of Commercial Cooking Operations, NFPA 96-1994.



DO NOT Modify, Alter or Add Attachments to This Equipment!

The above steps will help to ensure safe and proper installation of your fryer. If you have any questions concerning these procedures, contact your local Giles distributor or other qualified service person.

Gas Fryer Setup Instructions “All Units”

- 
1. Check location elevation and verify unit is setup for proper elevation.
 2. Fill the cooking vessel with water.
 3. Turn off gas supply.
 4. Turn off power.
 5. Remove the back panel(s) upper and lower.
 6. Remove the gas line (tube) from the orifice holder (bottom of the burner).
 7. Remove the orifice holder by turning it counter clockwise. The altitude is stamped on the orifice. Verify that the orifice size is for the correct altitude.
 8. Put the orifice holder back in place.
 9. Locate the pressure tap on the gas valve and take out the plug.
 10. Connect a water column (manometer) to the gas valve. (Where you removed the plug from).
 11. Turn the power on.
 12. Turn on gas supply and read water column 10.5 inches LP or 3.5 inches natural.
 13. Adjust gas pressure as required. By removing the cap on the valve covering the pressure adjustment screw. (If pressure is correct, do not adjust).
 14. Turn off gas supply.
 15. Turn off the power.
 16. Remove the water column from the gas valve.
 17. Put the plug back in place.
 18. Put the back panel(s) back on the unit.
 19. Turn on the gas supply.
 20. Turn on the power.
 21. The unit is ready for operation.
 22. Proceed with the boil out procedure.

*** Check Vacuum Switch Operation With Procedure, 2nd Page***

Gas Fryer Setup Instructions "All Units"

1. Using a non-combustible cover, place it over the vent stack covering half of the stack.
2. The unit burner should be shut off, after removing the cover, the unit will re-ignite.
3. Adjust the vacuum switch if the unit doesn't shut off when covered.
4. Turning the adjusting screw clockwise increases sensitivity.
5. If it takes more coverage to shut down the unit, the switch is not sensitive enough, if covering only 1/4 shuts the unit down, it too sensitive.

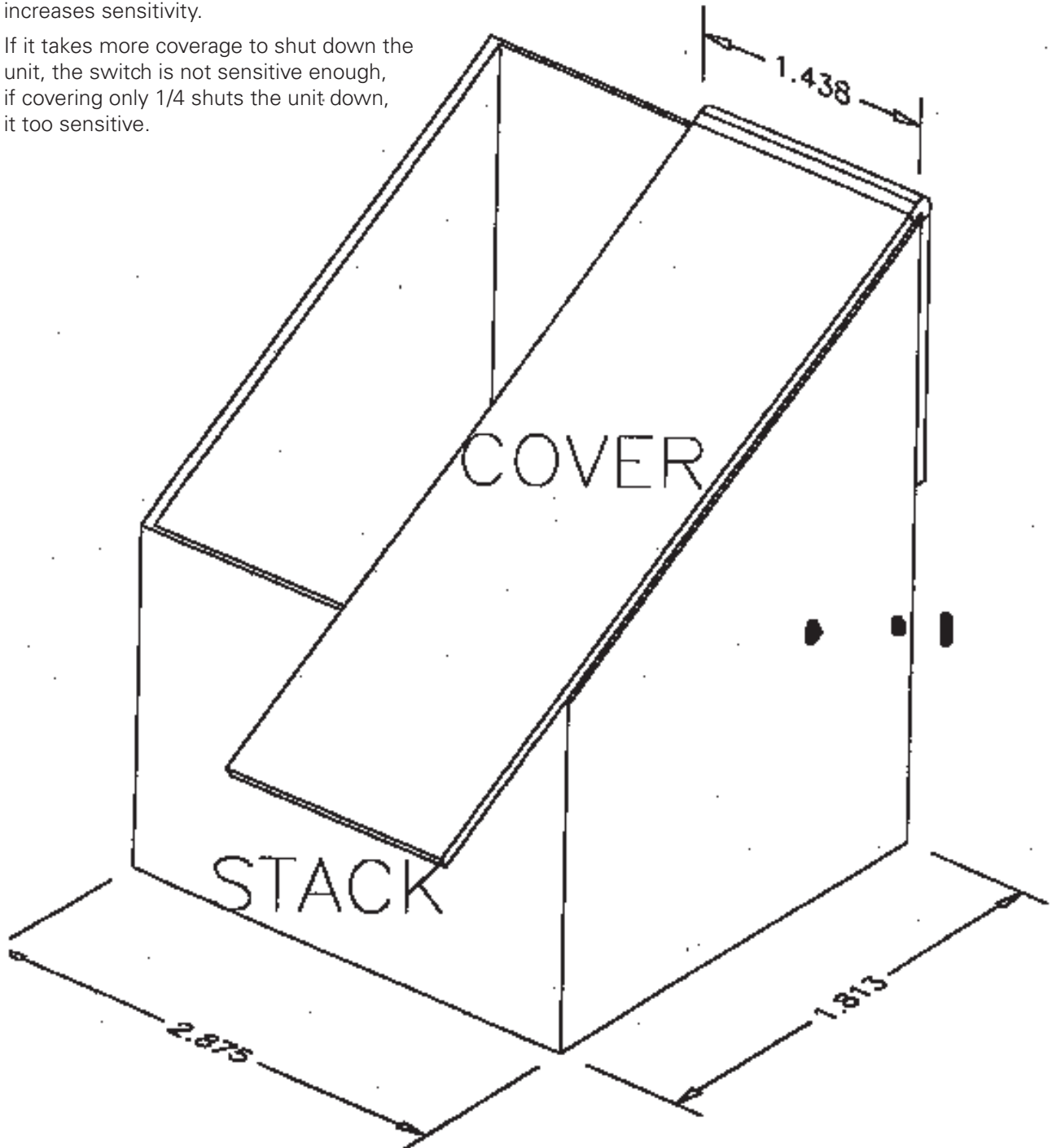

Installation

1 - 2 Removal of Fryer from Crate

Your Giles Fryer may arrive enclosed by a wooden crate. If your unit arrived uncrated, go to Section 1-3. The Fryer is secured to a wooden platform by means of high-tensile strength strapping.

1. Carefully cut and remove the plastic shipping wrap and the strapping mentioned above.
2. Use pliers to loosen wire hooks which secure the wooden crate around the fryer. Remove the wooden crate.
3. Carefully remove the fryer from the shipping platform. Your new fryer is extremely heavy and great care should be taken in lifting or moving the unit to prevent personal injury or equipment damage.

1 - 3 Ventilation of Fryer

Your new Giles Gas Fryer has been designed for operation beneath a traditional exhaust hood. We strongly recommend you consult a professional ventilation or heating and air conditioning company for assistance in designing a hood for an exhaust system.

IMPORTANT NOTE

Guidelines for proper ventilation system requirements may differ. Always consult with local authorities to ensure compliance.

1 - 4 Electrical Requirements



WARNING

Fryers must be adequately and properly grounded. Improper grounding may result in electrical shock. Always refer to your local electrical code to ensure proper grounding of this or any other electrical equipment. Always consult with an electrician or other qualified service person to ensure breakers and wiring are of sufficient rating and gauge for the equipment being operated.

Giles Fryers are available from the factory wired for 120, 208 or 240 volts, and single phase only, 50/60HZ. service and set for either Natural or LP Gas. Check the rating plate on the door of the fryer to determine the correct power supply and fuel type.

Operating Instructions



2 Operating Instructions

For your safety, please observe the following precautions when operating your Giles Fryer:

1. Ensure the fry kettle is positioned in a secure, safe location with the casters in the locked position. A restraining device attachment ring is located on the lower right hand side of the Fryer.
2. Due to the high temperature of shortening in your fryer during cooking, it is extremely important the user exercise caution in operating this equipment to avoid personal injury.
3. Never move a fryer that contains hot oil! To avoid hazards associated with moving a fryer with liquid in the vessel, always allow adequate time for the liquid to cool.
4. If for any reason it becomes necessary to disconnect the fryer's restraining device, ensure the restraining device is reconnected and the Fryer is returned to its original installed position.
5. Make sure all electrical and gas specifications have been met and the unit is grounded (see wiring diagram in Section 10).
6. In the event of power failure, DO NOT try to operate the unit.

Lighting and Shut-Down Instructions

1. Open the Main Gas Valve, turn Power Switch on.
2. Set the Thermostat to the desired temperature. (Giles Gas Fryers are provided with an automatic direct ignition system which eliminates the need for a pilot light).
3. In the event the burner does not ignite, a beeper will sound. Wait 5 minutes before attempting to restart the Fryer.
4. To RESTART, switch the Fryer's main Power Switch to the "OFF" position. Return the Main Power Switch to the "ON" position and set the desired temperature.
5. To SHUT-DOWN the Fryer, turn the thermostat and the Fryer's Main Power Switch to the "OFF" position, then CLOSE the Gas Supply Valve.

Model CF-400G



Fryer Components and Their Functions



3 Fryer Components and Their Functions

The following section is designed to introduce you to the controls used in operating this equipment.



DO NOT attempt operation of this unit until you have located each control discussed and fully understand their intended function. Failure to do so may result in improper operation resulting in equipment damage or personal injury to the operator.

Please review this section carefully before proceeding any further.

Refer to the accompanying photographs for the location of the components discussed.

Cooking Computer Control Panel Components and Their Functions

<i>ITEM</i>	<i>DESCRIPTION</i>	<i>FUNCTION</i>
1. Fig. 1	Power Switch	The Power Switch is a two-position switch. Move the switch upward to the "ON" position for operation.
2. Fig. 1	Selector Switch	The Selector Switch is a three-position switch which is used to select either the cook, off or filter mode of operation. The fryer's Heat Exchanger will only operate in the "COOK" position. The switch should be placed in the "FILTER" position to filter the shortening which will allow the pump to operate.
3. Fig. 1	Cooking computer	The Cooking Computer is used to select oil temperatures, cooking times and basket lift operations. Programming of the cooking computer is covered later in the manual.

Model CF-400G

3 - 1 Control Panel

Figure 1

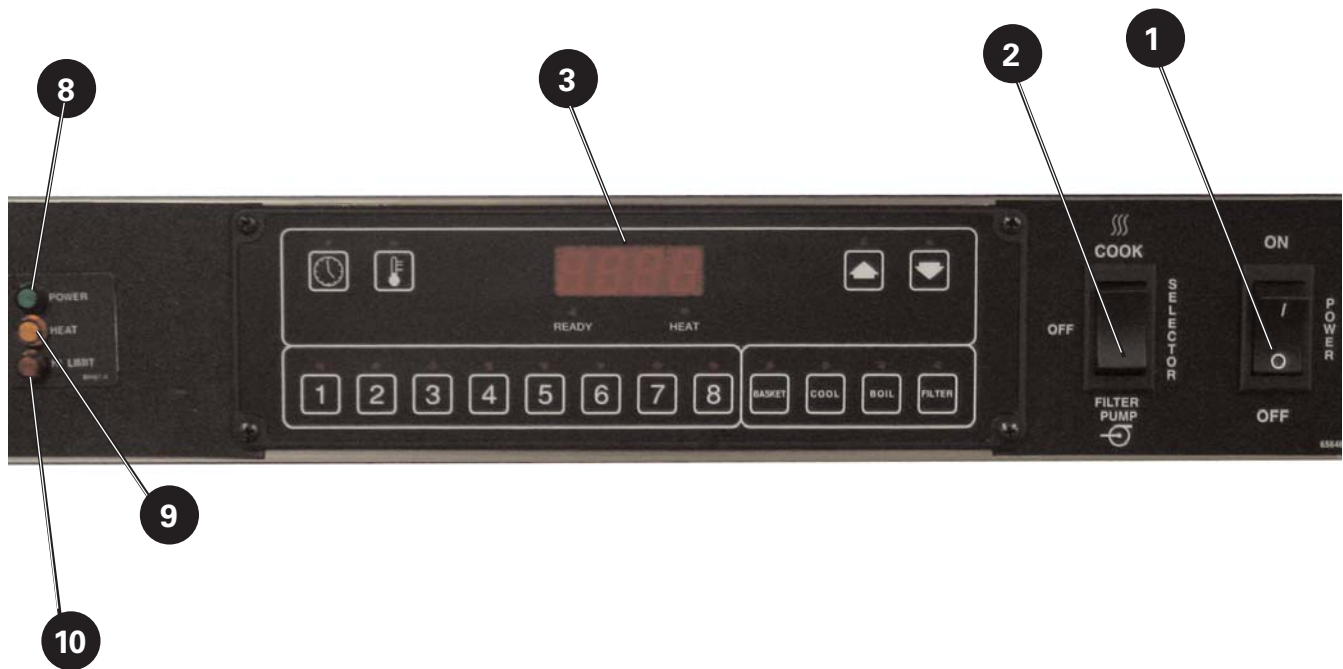

ITEM	DESCRIPTION	FUNCTION
8. Fig. 1	Power Indicator Light	The Green Power Light is on whenever the fryer's Master Power Switch is in the "ON" position.
9. Fig. 1	Heat Indicator Light	The Orange Heat Indicator Light will be on when the fryer's Heat Exchanger is operating. When the selected operating temperature is reached, the light will go off.
10. Fig 1	High-Limit Indicator	The High-Limit Indicator Light is illuminated as a result of power being shut off to the fryer's Heat Exchanger by the built-in solid-state control circuit. If it comes on during operation, refer to the trouble-shooting section of this manual.

NEVER cook in a fryer with the High-Limit Light on!

Fryer Components and Their Functions

3 - 2 Lower Cabinet Area

ITEM	DESCRIPTION	FUNCTION
1. Fig. 2	Filter Pan Hold-Down Bracket and Latches	The Hold-Down Bracket is contained in the filter pan and serves to ensure the filter paper is held tightly in place by means of the four locking latches. The fryer's filtering action will be reduced or eliminated if these latches are not properly secured.
2. Fig. 2	T-Handle/Drain Valve	Turning this T-Handle counter-clockwise allows shortening to drain from the frying vessel into the filter pan. Open the valve slowly to avoid burns from splashing of hot oil. Always ensure the valve is closed prior to adding shortening. Your fryer will not operate if this Drain Valve is not completely closed. (i.e., clockwise)
3. Fig. 2	Drain Valve Pipe-Drain	This Pipe-Drain attaches to the Drain Valve and helps to minimize splashing of hot oil when the fry-kettle is filtered or drained. The Pipe-Drain must be removed before sliding the filter pan out of the fryer. Always use insulated gloves to remove this hand tightened pipe.
4. Fig. 2	Quick Disconnect Oil Discharge Wand	This Quick-Disconnect Fitting is used in conjunction with the oil discharge wand to remove oil from the fryer that is to be discharged.
5. Fig. 2	Diverter Valve	The Diverter Valve may be identified by its colored lever-type handle. During a normal operation, it should be positioned so it points outward toward the operator. For removal of oil with the discharge hose connected, the diverter valve handle should be turned inward and counter-clockwise. After removal of oil for discard it should be returned to its normal position pointing toward the operator. Details of the oil procedure are covered in the operations section of this manual.
6. Fig. 2	Quick Disconnect For filter Pan	This Quick Disconnect fitting serves to connect the hose from the filter pan to the fryer's oil return lines. The hose must be disconnected at this fitting prior to sliding the filter pan outward for cleaning or removal. The fitting is operated by pushing upward on the insulating ring and exerting downward pressure on the connecting end of the hose. For reconnection, push upward on the insulating ring while inserting the hose. Release the insulating ring when the hose fitting is fully inserted to lock it in position.

Model CF-400G

ITEM	DESCRIPTION	FUNCTION
7. Fig. 2	Filter Pan	The Filter Pan contains the filter paper which serves to remove breading and other impurities from the oil during the filtering procedure. Oil is drained into the filter pan where the fryer's pumping action draws it through the filter paper and returns it to the cooking vessel by way of the Filter Pan Hose.

Figure 2 Lower Cabinet Area

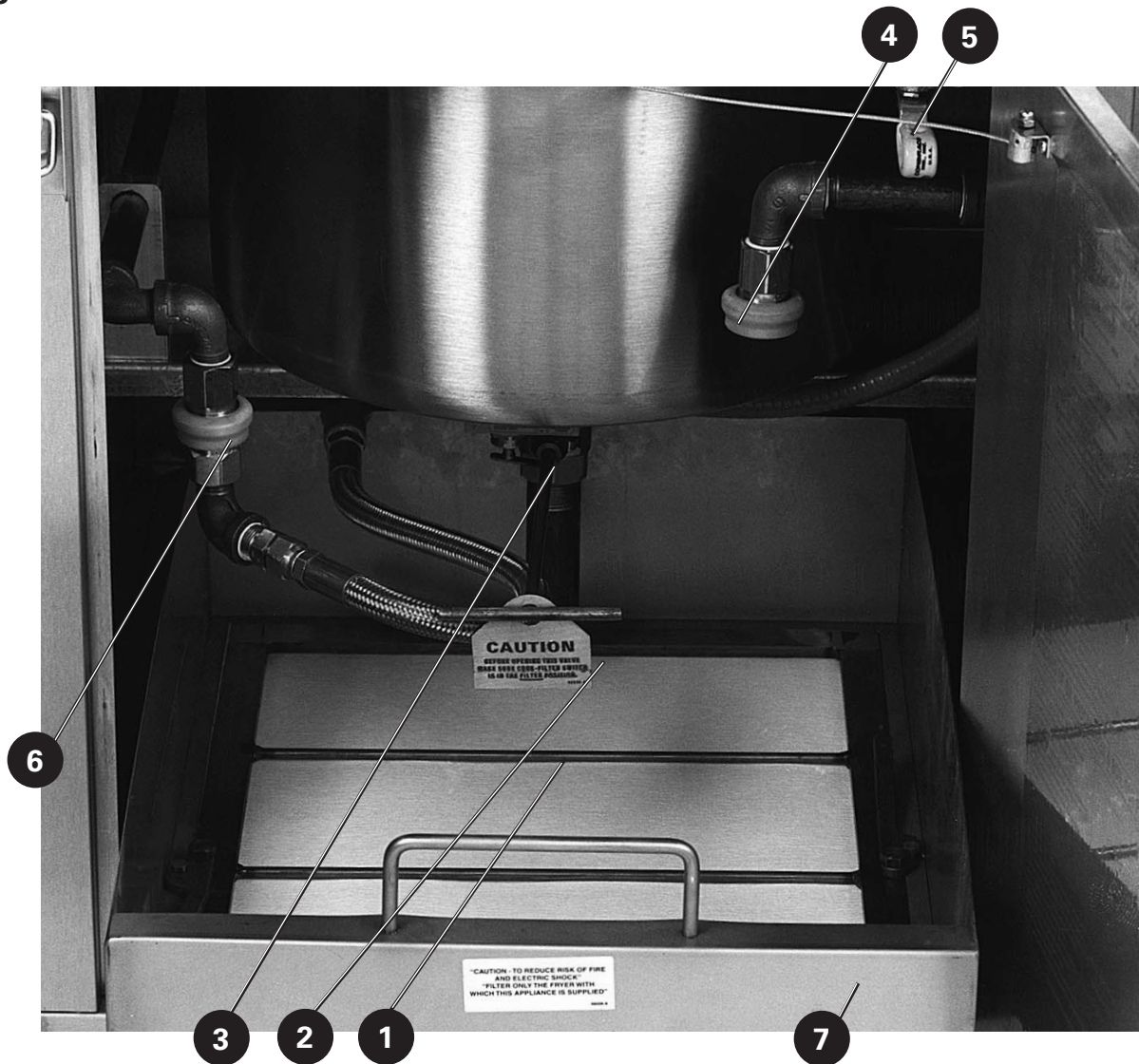

Fryer Components and Their Functions

3 - 3 Cooking Vessel

<i>ITEM</i>	<i>DESCRIPTION</i>	<i>FUNCTION</i>
1. Fig. 3	Oil Temp Probe	The Oil Temp Probe senses oil temperature during fryer operation for temperature control. Its signal is directed to the fryer's control unit for comparison with the temperature selected by remote set-pot on the operator control panel.
2. Fig. 3	Heat Exchanger	The Heating Element heats the shortening to the selected temperature. Always maintain the cold oil level above the Heat Exchanger to prevent oil fires!
3. Fig. 3	Basket Carrier	The Basket Carrier is inserted into the elevator shaft and allows for positioning and control of the basket in the fryer using the elevator lift.
4. Fig. 3	Oil Return Inlet	The Oil Return Inlet serves to return oil to the frying vessel following filtering.
5. Fig. 3	High-Limit Probe	The High-Limit Probe senses oil temperature during fryer operation for oil overheating. If the sensor detects an oil temperature in excess of 424°F (218°C), the solid state control system will turn off power to the Heat Exchanger.
6. Fig. 3	Oil Level Line	The Oil Level Line marks the proper level of HOT shortening. When COLD, the shortening will be approximately ³ / ₄ " (1.9cm) below the Oil Level Line. The proper shortening level is important and should be checked a minimum of once per day.

Model CF-400G

Figure 3 Cooking Vessel

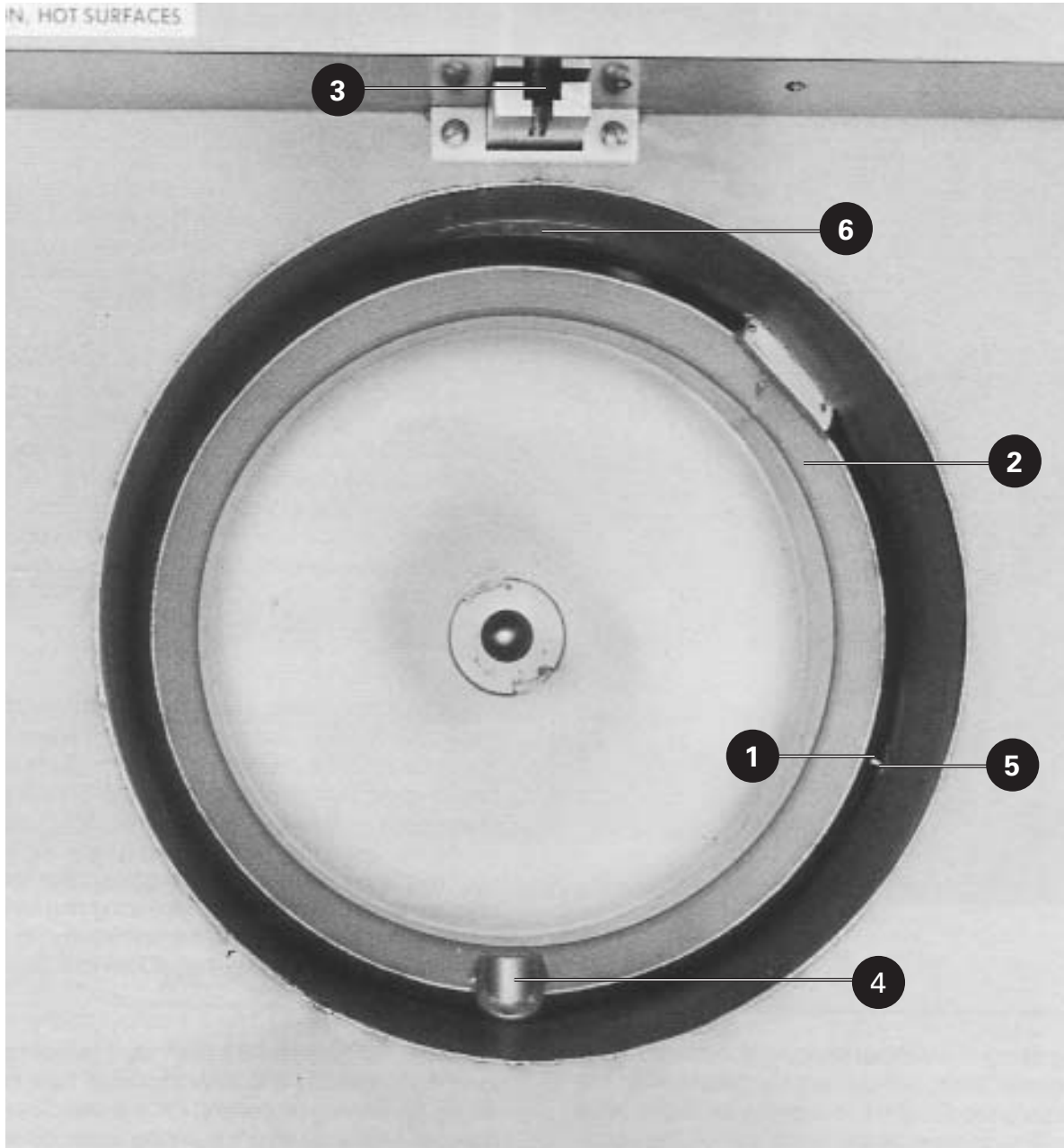

Fryer Components and Their Functions

3 - 4 Cooking Computer Features

To help you understand the many programming features of the cooking computer, we strongly suggest you read the following:

Melt Cycle

This melt cycle is shipped to you OFF and must be turned ON for those fryer users who occasionally or regularly use SOLID SHORTENING. (Shortening which is slushy at room temperature is not considered solid.)

For SOLID SHORTENING users, the melt cycle typically increases a 335°F (168°C) initial daily preheat time to 45 minutes. The ON melt cycle with SOLID SHORTENING prevents solid shortening from scorching and greatly reduces the chance of a solid shortening oil fire on initial preheat.

It is the responsibility of you, the end user, to tell your equipment supplier/installer of any solid shortening use so they can program your "melt" cycle "ON".

In the event your equipment supplier cannot be reached to set up your controller for melt cycle operation, you can call our factory service department toll free at 1-800-288-1555 and we will tell you how to set the controller to melt cycle mode.

Cool Down Cycle

After any of your 8 menu time cycles end (00.00) and your fryer is not required for use for an hour or more, you can reduce energy cost by pressing the "COOL" key. This key will allow the hot oil to cool down to 275°F (135°C) for stand by use. When your fryer is required for use after being in the "cool cycle" merely press the COOL key again and the fryer will go back to the last lighted menu key's programmed temperature. When the orange heat light goes off in approximately 3-4 minutes, stir the oil vigorously until the heat light comes on again. When the orange heat light goes off for the second time, the oil will be ready for use.

Filter Cycle and Alarm

Giles recommends you filter your oil after every 4th full load of chicken. Filtering cleans the breading sediment out of the fry pot and removes contaminants from the oil. The filtering process can greatly extend the oil life. At the end of every 4th load "FILT" will flash up on the display and a repeating 2 sec on ¹/₂ second off sound alarm will be heard. The filter alarm indicates it is time to filter the oil.

IMPORTANT NOTE

The sound alarm can be silenced by pressing the "FILTER" key.

Stir Cycle and Alarm

Your fryer is equipped with a stir message and a repeating one second on/one second off sound alarm telling you it is time to stir you product. This feature is a Giles "preset time" of 62% of each of the 8 menu times previously set to prevent the chicken from sticking to itself. When the stir alarm sounds, stir the chicken and then silence the alarm by pressing the lighted menu key once.

End of Menu and Alarm

At the end of each of 8 menu key times (00.00), the fry basket will come up and a 10 second continuous sound alarm will be heard. To silence the alarm before 10 seconds are up, merely press the lighted menu key once.

Model CF-400G

3 - 5 Computer Function Keys

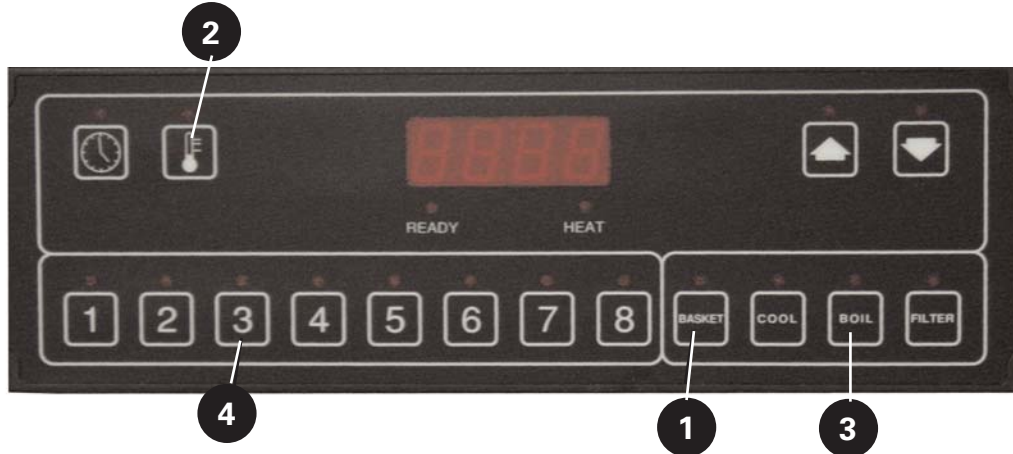

The following is a description of the basic function and operation of your cooking computer's key pad.

1. Basket Key

When the basket key is pressed once, the up and down arrow keys blink. If the basket is up, it can only be lowered using the down arrow key. Once the basket key is pressed you have 20 seconds to select your basket arrow direction or you must push it again after the basket key light goes off. Once the basket key is pressed, and the proper arrow key is pressed within 20 seconds, the basket travels either up or down. Any menu cycle can be started while the basket is in motion. The basket cannot be stopped during it's up or down travel. Allow 20 seconds for the basket travel time to change basket direction of travel if required.

2. Temperature Bulb Key

To check the temperature setting of any lighted menu key, simply press the temperature bulb key and for 3 seconds the temperature will display and then return to 00:00 or the time remaining in that menu countdown.

3. Boil Cycle Key (For use with boil out procedure portion of this manual only)!

The boil cycle feature is used for cleaning the fryer by using fryer heated cold water & Boil out powder (part #72004). When the Boil key is pressed and held for 5 seconds, and no menu is active (00:00), the red boil light will come on and the display will alternately flash boil and 00:00. This activates a fixed temperature setting of 200°F (93°C). The water and Chester Clean will not boil at 200°F (93°C), but it will clean the fry pot and keep the Boil-out solution from possibly boiling over on the floor.

- a. When this cycle is considered complete (fryer clean), turn off the fryer power rocker switch.
- b. Drain and wash out the fry pot.
- c. Refill with room temperature oil to 1/4" (64cm) below the oil line before turning fryer on!

When the fryer is turned on, the computer will heat the oil to the menu 1 key temperature. To heat it to a different menu key temperature, merely press your desired menu key twice.

Fryer Components and Their Functions

4 Menu Keys 1 thru 8

At the end of any menu 1 - 8, the 10 second long continuous alarm can also be silenced prior to the 10 second ending by pressing the lighted menu key. When counting down time without the alarm sounding, pressing the lighted menu key will reset that menu key to 00:00. You cannot raise the basket when canceling out a menu in progress by pressing the lighted menu key! The basket can only be raised by pressing the basket key and then the up arrow !











Your cooking computer has many various capabilities to meet many special end user needs. Our service department at 1-800-554-4537 stands ready to answer special questions. We can adjust the end of menu alarm, both loudness and sound pattern. We can also easily give you time compensation, as well as several other special performance items that only a world class computer can perform!

3 - 6 Cooking Computer Programming

The first step is to determine the time and temperature for each product. The CF-400G recommended times and temperatures for fried chicken are 335°F (168°C) for 13:00 minutes. Channel 1 is the only menu key programmed for 335°F (168°C) and 13:00 minutes, when you receive your fryer. All other menu keys will require programming or reprogramming. Menu keys 2 thru 8 will be preset to 200°F (93°C) for 00:00 time and cannot be accessed to cook on until programmed (details on following page) with a product time and temperature.



How to Program Menu Temperatures & Times on Menu Keys 1 thru 8

1. Press power rocker switch to on. (Green indicator light comes on)
2. Press  &  keys simultaneously for (6) seconds until **SP 1** flashes alternately with the preset menu temperature.
3. Press desired menu key to be programmed. (Red light comes on over key)
4. Press  &  keys to desired menu temperature.
5. Press lighted menu key again **t 1** flashes alternately with set time.
6. Press  &  keys to desired menu time in **min:sec**
7. Press next menu key for programming if desired & repeat steps 4 thru 7.
8. When menu keys are programmed press  & **LOC** appears. If you want all entered menu temperatures & times secured press  & **1** will be displayed. If you don't want program security press  & **0** will be displayed.
9. Press  once more & you will exit program mode & **00:00** appears.
10. After orange heat light goes off, pressing any programmed menu key will start that menu temperature/time cycle. **Always press the menu key after last piece per load is dropped in the basket.**

IMPORTANT NOTE:

During the above process, if no keys are pressed for 60 seconds the computer will jump out of the program mode & you will have to start over if your programming is not complete. Any of your programmed temperatures & times will be retained unless reprogramming occurs.

Model CF-400G

4 Testing the Fryer

We at Giles take pride in the quality of our workmanship. Every effort has been made to ensure your unit is in good operating condition when you receive it. Each unit must pass a rigorous quality control test prior to shipment. To further ensure optimum operation of your new unit, we recommend a brief operational check-out of your new fryer.

CAUTION

Before attempting to operate the unit, refer to Section 3 to familiarize yourself with the various control functions. Once you have read and fully understand Section 3, please follow the steps below precisely in order to prevent equipment damage or malfunction.

4 - 1 Proper Control Settings for Check-Out

1. Place all switches in the "OFF" position.
2. Remove fryer lid.
3. Remove the basket or other accessory items from the fry-kettle.
4. Turn on the circuit breaker which supplies power to the unit.
5. Place the fryer's main Power Switch to "ON". The green power light should be illuminated. If the power light fails to illuminate, refer to the appropriate section of the troubleshooting guide. If the green power light illuminates, proceed to the next step.

4 - 2 Operational Check of Burner System

This step is designed to ensure your fryer's Heat Exchanger is functioning.

WARNING

DO NOT touch the Heat Exchanger during this portion of the check-out. The Heat Exchanger is very hot and skin contact with it may result in severe burns.

1. Wipe the dry cool Heat Exchanger with a wet sponge.

CAUTION

This portion of the check-out requires the Burner System be activated. DO NOT operate the Burner System for more than 10 seconds without Heat Exchanger being fully covered by shortening. Failure to observe this precaution may result in damage to the Heat Exchanger and Burner System.

2. With the fryer's lid removed, briefly turn the Selector Switch to the COOK position (max. 10 sec.). Then return it to the "OFF" position.

Fryer Components and Their Functions

4 - 2 Operational Check of Burner System (*continued*)

3. The wet heat exchanger should dry within 15 seconds after fryer element shut-off signifying heat.
4. If the Burner System does not appear operational, refer to the troubleshooting guide.
5. If the Burner System is operational, clean the fryer as described under instructions for the boil-out procedure described in this manual, Section 5-1.
6. After thorough cleaning, fill fry pot to proper level with shortening.

4 - 3 Operational Check-Out of the Filter Pump

1. Open the fryer's front door.
2. Disconnect the filter-pan hose by lifting the insulating ring on the Quick-Disconnect and pull the hose out of this fitting.

CAUTION

The following step requires starting of the fryer's filter pump in a "DRY" condition. The pump should only be operated for a few seconds in this manner or damage to the unit will occur.

3. Place the fryer's Power Switch to the "ON" position.
4. Place your palm over the Quick-Disconnect at the point where the nose from the filter-pan connects.
5. Briefly place the Selector Switch in the "FILTER" position. If suction is felt on the hand covering the Quick-Disconnect, the pump is operational. If the above steps are followed and no suction is felt, consult the troubleshooting guide.

Testing the Fryer

5 Preparing the Fryer for Operation

Your new fryer should be cleaned thoroughly before actual cooking takes place. To accomplish this, follow the procedure described in the following Boil-Out Procedure section.

5 - 1 Fryer Boil-Out Procedure

This section describes the cleaning process for your fryer known as the “Boil-Out.” A “Boil-Out” should be performed on the new equipment prior to actual cooking and every time shortening is removed from the fryer for cleaning of the fry-kettle and refill with fresh shortening.

WARNING

Please perform the steps of this procedure as described to avoid possible equipment damage, violation of warranty provisions or personal injury.

1. Always use thermal oven mitts during this procedure to protect skin from burns due to splashing of hot liquids.
2. If you are performing a “Boil-Out” on a new fryer which DOES NOT contain shortening, go to Step 19, otherwise proceed to Step 3.
3. If the shortening in the fryer is not in a heated state (at least 200°F) (93°C), go to Step 4. If the fryer has been in operation and the shortening is in a heated state, place the Selector Switch in the “OFF” position and allow the shortening to cool for 2 minutes before continuing.
4. If the shortening in the fryer is cold, that is at room temperature, you must first heat the shortening briefly so it is liquid enough to be removed by the fryer’s filter system. To do this, turn the main Power Switch to “ON” and the Selector Switch to “COOK.” Turn the Temperature Select Knob to 200°F (93°C) and heat the oil until the orange heat indicator light goes off. Stir the shortening well to ensure it is fully dissolved. Stirring may cause the orange heat light to come on again briefly. When the orange light goes off again, place the Selector Switch in the “OFF” position and go to Step 5.
5. Ensure the Selector Switch is in the “OFF” position before proceeding.

WARNING

The next step of this procedure requires the shortening be drained from the fry-kettle into the fryer’s filter pan. Failure to ensure the fryer’s Selector Switch is in the “OFF” position prior to draining may result in fire on the exposed Heat Exchanger. Always ensure the Selector Switch is in the proper position.

6. Slowly open the T-Handle located on the drain beneath the fry-kettle. The drain is opened by turning it counter-clockwise. Use care in opening this valve to avoid being splashed by hot oil. (You may find the drain requires insertion of the smaller brush enclosed with the fryer in order to free the valve of breading which may clog it. The brush should be inserted from above. Be careful not to puncture the filter paper when using this brush).
7. Ensure the diverter valve is positioned so its handle points toward the operator.

Testing the Fryer

5 - 1 Fryer Boil-Out Procedure (*continued*)

- Place Pump Switch in the "ON" position and allow shortening to return to the fry-kettle and out through the drain. Use this opportunity to "Wash-Down" breadings which has accumulated in the bottom of fry-kettle. Use the larger pot brush supplied with the fryer to help "Wash-Down" this material into the filter-pan below.

Use care to avoid being splashed and burned by the hot oil.

Figure 6 Lower Cabinet Area

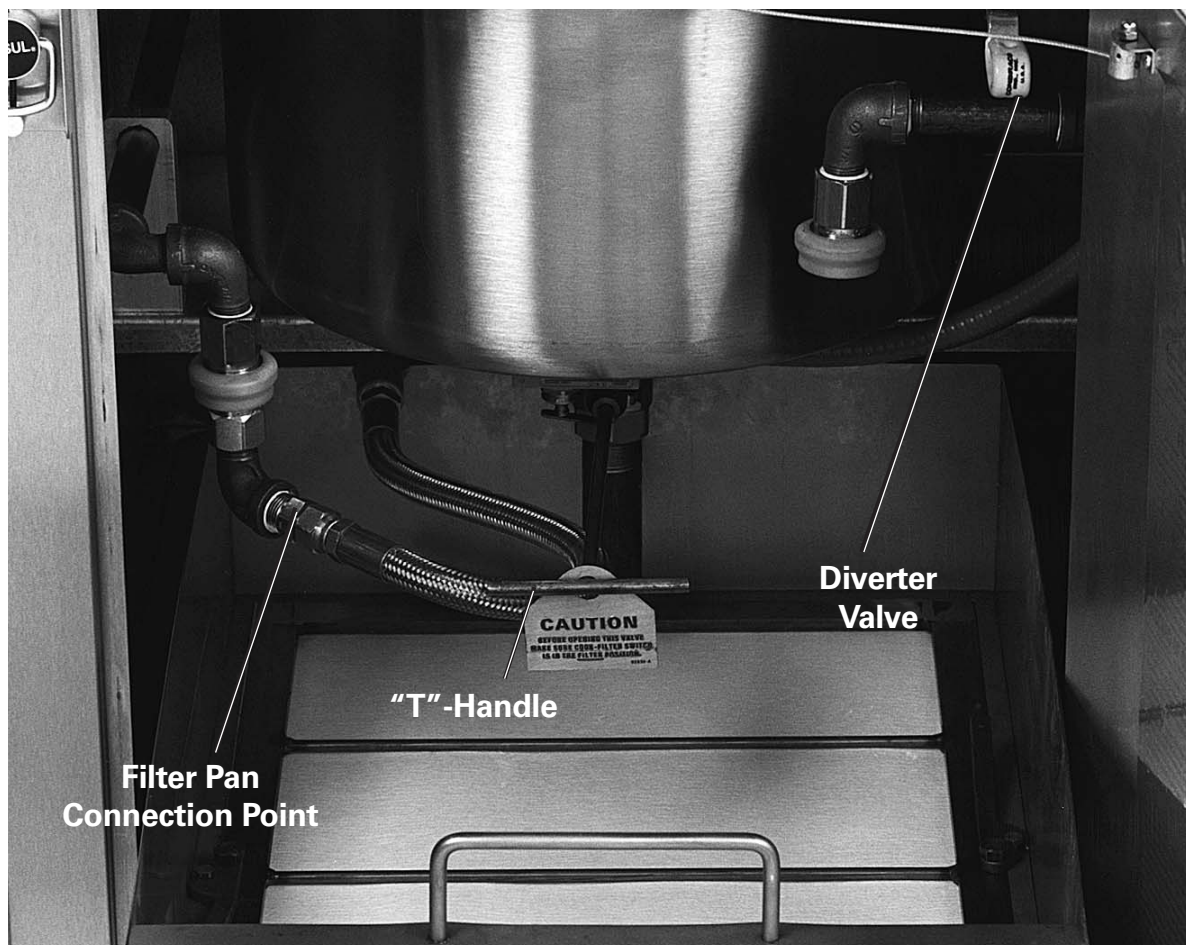

Model CF-400G

Figure 7 Filter Pan Shown with Drain Hose Attached



Preparing the Fryer for Operation

5 - 1 Fryer Boil-Out Procedure (*continued*)

9. After “Washing Down” all accumulated breading and crumbs from the bottom of the fry-kettle, place the Pump Switch in the “Off” position and allow the shortening to drain into the filter pan.
10. Turn the Diverter Valve Handle on the Drain Valve clockwise to close.
11. Position an appropriate receptacle for the oil you are to discard near the front of the fryer. **Remember, you will be removing approximately 5 gallons (19L) of shortening. Please ensure the container which you have selected will contain all of the shortening.** For ease in handling, you may find it helpful to use more than a single container. **The shortening you will remove weighs about 35 lbs (16k) and is still very hot.** Placing the discarded shortening in two or more containers for removal makes for a lighter load and decreases the possibility of injury by splashing. We recommend our Oil Caddy (Part #79229A) for this purpose, because the shortening can safely be removed at one time.



WARNING

ALWAYS ENSURE THAT THE CONTAINERS BEING USED FOR THIS STEP WILL SAFELY HOLD OIL! Plastic is generally not safe as it may melt and break. Metal containers which do not leak are preferable to containers made of other materials. Failure to follow the above precautions may result in serious injury.

12. Connect the discharge drain hose to the quick disconnect located beside the diverter valve. Always ensure the hose coupling is securely mated at the quick disconnected fitting.
13. Turn the handle on the diverter valve to the left. (Clockwise)



CAUTION

DO NOT run boil-out through the filter pump. Doing so can damage the pump and void the warranty.

14. Position the hand-held wand end of the discharge hose over the receptacle which you have positioned to receive the HOT waste oil from the fryer. Always grasp the discharge hose by the insulated sleeve near the wand end.
15. Place the Selector Switch in the “FILTER” position and allow the fryer filter system to pump the HOT waste oil out of the fryer through the drain hose.
16. When all waste oil has been removed from the fryer, return the Selector Switch to the “OFF” position.
17. Return the diverter handle to its normal position so it points towards the operator.
18. Disconnect the drain hose from the fryer at the quick disconnect fitting below the diverter valve. Always hold both ends of the drain hose in an upright position to avoid spillage of residual oil which may be trapped in the hose. Carefully drain the hose into the receptacle which contains the waste oil from the fryer.
19. Disconnect the filter pan from the fryer at the quick disconnect fitting located above and to-the-left of the filter pan.

Preparing the Fryer for Operation

20. Remove the pipe-drain from the fry-kettle Drain Valve threading it in a counter-clockwise direction.
21. Slide the filter pan forward and carefully remove it for cleaning. NOTE: We recommend you use Chester Clean or an alkaline based cleanser to clean the filter pan. Avoid liquid dish washing detergents as they may leave residues which reduce shortening life.
22. Ensure the Drain Valve is closed by turning the T-Handle fully clockwise.
23. Fill the fryer with water to the Oil Level Line.
24. Carefully add Chester Clean to the water following the directions on the container.

CAUTION

If you choose to use a cleaner other than Chester Clean to “Boil-Out” your fryer, pay close attention to the instructions listed on the container. Many commercially available cleaners are caustic chemicals which require special precautions for use. If used improperly, these chemicals may cause damage to your fryer and potential injury to the user.

25. Press boil key for 6 seconds until red light illuminates.

CAUTION

DO NOT UNDER ANY CIRCUMSTANCES LEAVE THE FRYER UNATTENDED during this procedure as heat must be carefully monitored to prevent the fry-kettle from overflow due to boiling. Overflow of the fry-kettle may result in serious equipment damage. In the event of near boil over, flip the Power Switch off!

26. Set the Selector Switch in the “COOK” position.
27. Heat the cleaning solution for 30 minutes. Scrub the interior of the fry-kettle with the large pot brush during this period to remove build-up.
28. Flip Selector Switch to the “Off” position.
29. Position a heat resistant pail beneath the Drain Valve at the bottom of the fry kettle. Slowly open the valve by turning the T-Handle counter-clockwise. Drain the cleaning solution from the fryer. Be careful not to overfill the container which will hold the cleaning solution drained from the fryer.
30. Close the Drain Valve by turning the T-Handle fully in a clockwise position.
31. Rinse the inside of the fry-kettle with fresh water and repeat the drain procedure described in step 29.
32. Mop out excess water from the fryer pot with a dry cloth.
33. Close the Drain Valve again.
34. Replace filter pan after thorough cleaning.

IMPORTANT NOTE

Do Not pump “Boil-Out” through filter pump. Doing so can damage pump and void warranty.

35. Fill fryer with shortening to the proper level. Shortening should reach the Oil Level Line when the oil is HOT.

Preparing the Fryer for Operation

5 - 2 Cleaning of Filter Pan/Replacement of Filter Paper

The following steps should be taken with the filter pan removed from the fryer. The filter pan should be thoroughly cleansed during each "Boil Out" procedure. **Do not attempt to clean the Filter Pan when the pan is still in the fryer cabinet.**

1. Remove accumulated breading and residue from the surface of the filter paper with the metal crumb shovel supplied with the fryer. Remove residue from the small edge which surrounds the Hold-Down frame.
2. Release the four Hold-Down latches which secure the frame which holds the filter paper in place.
3. Remove the Hold-Down frame from the filter pan and place it in the sink for cleaning. Note - Use only Chester Clean or a suitable alkaline based cleaner to clean the Hold-Down frame as well as the other interior surfaces and components of the filter pan. LIQUID DISH WASHING DETERGENTS MAY LEAVE RESIDUES WHICH REDUCE SHORTENING LIFE.
4. Beginning at one end of the filter pan, carefully roll up the filter paper and throw it away.
5. Remove the metal weave beneath the filter paper and place it in the sink for cleaning.
6. Drain any remaining oil from the bottom of the filter pan into a proper waste receptacle. You must lift and tilt the filter pan to accomplish this. The filter pan is heavy, so you should have assistance.
7. Clean the interior of the filter pan with one of the cleaners previously recommended. Clean beneath the oil pick-up tube located in the bottom of the filter pan with a knife blade or other similar thin, flat instrument. Rinse the pan interior and mop out excess water with a dry cloth or paper toweling.
8. Clean and rinse the wire rack and Hold-Down frame which you placed in the sink earlier. Dry them. The filter pan is now ready for re-assembly and installation of new filter paper.

Two sheets of paper are used in the filter pan. The filter pan must be removed from the fryer to change the filter paper. Both sheets should be changed following a "Boil-Out". During normal operation, the top sheet is discarded on a daily basis. The bottom sheet is then placed on top of a new sheet of filter paper and the filter paper is replaced in the filter pan with the Hold-Down frame. The following simple steps summarize the procedure for replacement of the filter paper on a daily basis.

Daily filter paper replacement is recommended!

Preparing the Fryer for Operation

Figure 9 Disassembled View of Filter Pan - All Models

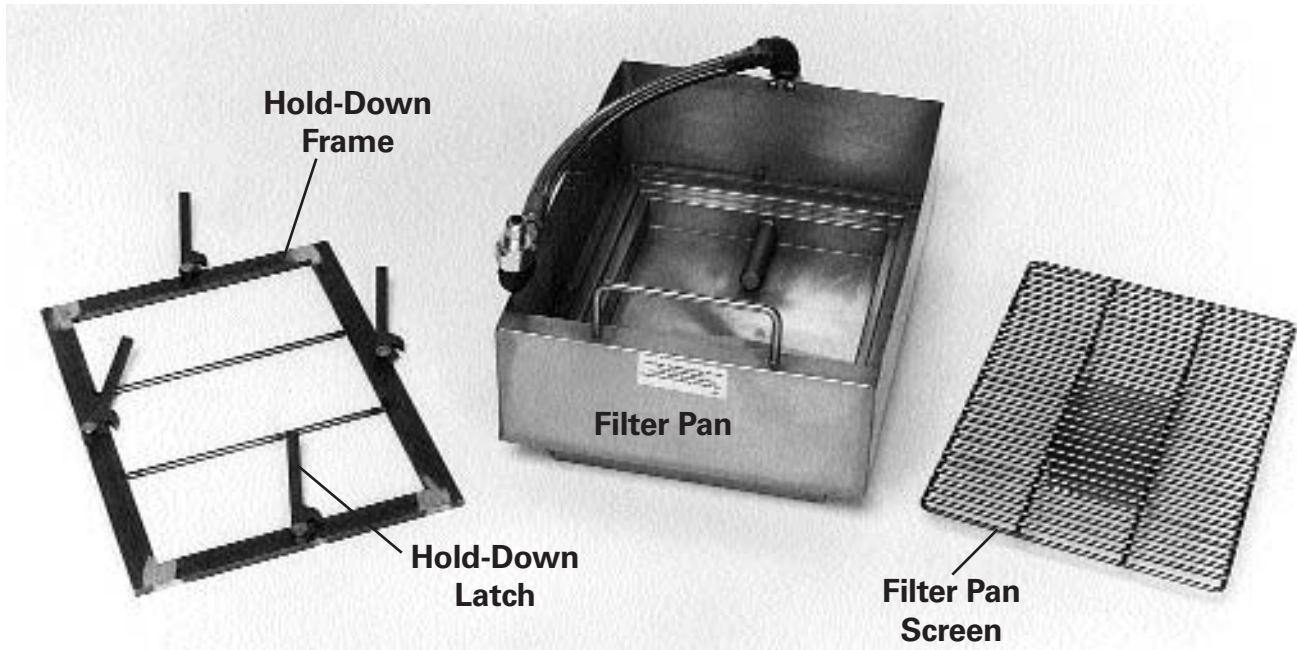

IMPORTANT NOTE

DAILY Filter Paper Replacement is Recommended!

Instructions for changing the Filter Paper:

1. Remove the crumb and breading residue which surrounds the Hold-Down rack that secures the filter paper in place.
2. Remove crumbs and breading residue from the top sheet of filter paper with the metal crumb shovel supplied with the fryer.
3. Release the four Hold-Down latches on the frame assembly which secures the filter paper.
4. Remove the Hold-Down Frame.
5. Carefully remove the top sheet of filter paper by lifting its corner or edge and rolling it towards the other end. Discard the paper.
6. Lift the edge of the bottom sheet and slip a clean sheet of filter paper beneath it.
7. Replace the Hold-Down rack above the filter paper and secure it with the four latches.
8. Replace the filter in the fryer and secure its hose connection with the quick disconnect fitting.

Preparing the Fryer for Operation

5 - 5 Operating the Fryer's Controls for Cooking

Before cooking with the fryer, ensure you have read and fully understand the intended functions of each control used on the fryer. Detailed explanations are found in Section 3 of this manual.

1. Fill fryer with shortening approximately 1/4"(1.9 cm) below the oil level located at the back of the fry kettle. The oil level line is for "Hot" shortening and additional shortening can be added after heating if necessary.
2. Place the fryer's Power Switch in the "ON" position (the green power light should come on).
3. Place the Selector Switch in the "COOK" position.
4. Use the Cook keys to select the desired cooking temperature. The orange heat light will glow as the oil is heated to the proper temperature. When the orange light goes out, stir the shortening vigorously to ensure it is completely heated. Stir the shortening until the orange light comes on again.
5. When the orange light goes out for the second time, the shortening will be at the selected cooking temperature.
6. Properly secure the fry basket to the basket carrier mounted to the fryer's elevator shaft.
7. Push the elevator Down Arrow Key. This will lower the basket into the heated shortening.
8. Carefully drop breaded food product into fry basket. Avoid splashing hot shortening.

Note - Food products should be placed in the fry basket after it is lowered into the hot oil. This prevents food products from sticking together. If the products to be cooked are frozen, they can be placed in the fry basket before lowering it into the shortening.

9. Push the desired menu key on electronic timers to start the timing cycle.
10. Place the fryer lid in its proper position on the fry-kettle.

Note - If you are cooking products which are not frozen, it is a good idea to remove the lid and stir the food with the stir paddle supplied with the fryer when the stir alarm sounds. This will help keep the food products from sticking together.

11. If you have removed the fryer lid to stir the food products, replace it and allow the cooking cycle to finish.
12. At the expiration of the selected time, the basket will be automatically lifted from the fryer and an end of the cycle alarm will sound.
13. Remove the lid, dump the fry basket into a suitable container (LT. Pan Part #79592A), and prepare the fryer for the next load.

Preparing the Fryer for Operation

5 - 6 Filtering the Fryer

The fryer should be filtered after every 4th load.

1. **Use thermal oven mitts during this procedure to prevent burns from hot oil and hot metal surfaces of the fryer.**
2. Ensure filter paper (2 pieces) is properly positioned in the filter pan as described in Section 4-2 under the section detailing replacement of the filter paper.
3. Place the Selector Switch in the "OFF" position.



WARNING

Failure to ensure the Selector Switch is in the "OFF" position during this procedure may result in equipment damage and/or personal injury.

4. Spread 12 ounces (.34kg) of Chester Fried filter powder in the filter pan. The filter powder helps extend shortening life by removing impurities.
5. Wearing thermal oven mitts, slowly open the T-Handle on the Drain Valve beneath the fry-kettle. Be very careful to avoid being splashed by hot oil.
6. Use the smaller diameter brush included with the fryer to open any clogs which might develop as you drain the oil into the filter pan.



CAUTION

Be careful not to puncture the filter paper when using the brush to unclog the drain valve.

7. Ensure the lever-type handle which controls the diverter valve is in the proper position for the filtering operation. The handle should be positioned so it is pointed outward toward the operator.
8. Place the Selector Switch in the "FILTER" position.
9. Leave the Drain Valve open and allow the filtered shortening to return to the fry-kettle and drain out the bottom through the Drain Valve. Use the larger brush included with the fryer to "Wash-Down" the fry-kettle and heat exchanger with the hot shortening as it circulates through the fry-kettle. Continue this for 3 minutes.
10. Close the Drain Valve completely by turning the T-Handle in a clockwise direction. Failure to close down completely will prevent fryer from operating.
11. Allow the filtered shortening to return to the fry-kettle. The oil will begin to bubble as the pumping action is completed, and the air fills the oil return lines. Place the Selector Switch in the "OFF" position.
12. Ensure the fryer contains the proper shortening level (See Oil Level Line).
13. Place the Selector Switch in the "COOK" position, push a cook key and allow shortening to reach the proper cooking temperature. This can be determined by observing the orange heat light.

Troubleshooting Model CF-400G

6 Troubleshooting Model CF-400G

6 - 1 Temperature Control System with Cooking Computer

<i>Problem</i>	<i>Probable Cause</i>	<i>Repair Procedure</i>
FRYER WILL NOT TURN ON No power light.	A. Not connected to power source. B. Bad fuse or circuit breaker. C. Fuse holder cracked. D. Power Switch bad. E. Improper supply voltage.	A. Connect to proper power source. B. Check fuse or breaker. C. Replace fuse holder. D. Replace Power Switch. E. Connect to proper voltage source.
FRYER WILL NOT HEAT Power light on. Heat light not on.	A. Selector Switch not in cook position.	A. Place selector to switch in cook position.
FRYER WILL NOT HEAT Power light on. Selector Switch in "COOK" position. Heat light not on.	A. Selected menu key programmed below preset oil temperature. B. Drain Valve open. B. Close Drain Valve. C. Cooking computer faulty. D. Variable probe shorted or open. E. Loose wire. F. Selector Switch bad.	A. Select new Menu Key or reprogram to desired temperature. C. Replace Cooking computer. D. Replace probe. E. Repair loose wire. F. Replace Selector Switch.
FRYER WILL NOT HEAT Power light on. Selector Switch in "COOK" position. High Limit light On.	A. Power surge. B. Oil level too low. C. Bad high limit board. D. High limit probe short or open. E. Line spikes or noise. F. Plug not completely in.	A. Turn Power Switch off for 5 sec. B. Fill to kettle oil level mark. C. Replace high limit board. D. Replace Hi limit probe. E. Filter line or remove noise source. F. Reconnect to Power Source.
FRYER WILL NOT HEAT Power light on. Selector Switch in "COOK" position. Fryer has an alarm going off.	A. Fan not up to speed. B. Gas Valve (main or fryers) closed. C. Ignition Module bad.	A. Check Voltage, replace Fan if necessary. B. Open Gas Valve. C. Replace Ignition Module.
FRYER HEATS SLOW (slow recovery) Heat light stays on.	A. Incorrect cooking procedures. B. Low Gas Pressure. C. Low supply Voltage. D. Wrong Orifice.	A. Consult operations manual for proper cooking procedure. B. Contact Gas Company. C. Supply Proper Voltage. D. Replace Orifice with proper size.
FRYER HEATS SLOW (short cycling) Heat light off and on continuously.	A. Variable probe touching heat exchanger B. Cooking computer faulty.	A. Reposition variable probe. B. Replace Cooking computer.

Troubleshooting *Model CF-400G*

6 - 2 Automatic Basket Lift and Oil Filtration System

<i>Problem</i>	<i>Probable Cause</i>	<i>Repair Procedure</i>
BASKET WILL NOT GO UP OR DOWN Elevator motor not on.	A. Power not on. B. Selector Switch not in "COOK" position. C. Cooking Computer faulty. D. Elevator micro switch out of adjustment. E. Elevator micro switch bad.	A. Turn Power Switch to "ON" position. B. Place Selector Switch in "COOK" position. C. Replace faulty Cooking Computer. D. Adjust micro switch. E. Replace micro switch.
BASKET WILL NOT GO UP OR DOWN Elevator Motor on. (Humming)	A. Basket over loaded. B. Elevator binding (slide bar dirty). C. Elevator motor gear box faulty. D. Drive sprocket set screw loose. E. Over tension on slide bar.	A. Put less product in basket. B. Clean slide bars. C. Replace elevator motor. D. Tighten drive sprocket set screw. E. Adjust slide bar tension.
BASKET GOES UP AND DOWN	A. Master link tab bent or broken. B. Micro switch out of adjustment. C. Improper tension on Slid bar..	A. Replace master link. B. Adjust micro switch. C. Adjust slid bar tension.
OIL NOT RETURNING TO VAT	A. COOK/FILTER switch not in "FILTER" position. B. Air leak (hose, fittings, filter paper). C. Bad pump motor capacitor. D. Pump motor is bad. E. Oil pump sticking.	A. Place Selector Switch in "FILTER" position. B. Repair air leak. C. Replace pump motor capacitor. D. Replace pump motor. E. Free stuck pump.
OIL PUMP STICKING	A. Boil out being run through pump. B. Old oil allowed to sit in pump. C. Solid shortening allowed to sit in pump.	A. Disassemble and re-oil pump. B. Run clean oil through pump. C. Disassemble and re-oil pump and clean out plumbing.
OIL TEMPERATURE ERRATIC	A. Probe bad. B. Flame Sensor bad. C. Cooking Computer faulty. D. Loose wire.	A. Replace probe. B. Replace Flame Sensor. C. Replace Cooking Computer. D. Repair loose wire.
OIL SMOKING	A. Old oil. B. Over temperature. C. Dirty Fry Kettle. D. Improper Gas type. E. Low oil level.	A. Change oil. B. Check temperature control system. C. Clean Fry Kettle. D. Use proper Gas type (LP or Nat.). E. Keep oil at oil level line.

Parts *Model CF-400G*

7 **Parts Model CF-400G**

Front Control Panel

Rear View of Lower Cabinet

Rear View of Header Section

Rear View of Upper Hood Section

Filter Pan Assembly

Parts Model CF-400G

7 - 1 Front Control Panel

Item No.	Part No.	Description	No. Req'd	Remarks
1	21190	Power Switch		
2	21189	Selector Switch		
3	24241	Cooking Computer		
5	38217	Power/Heat/High-Limit Light 208/240VAC		
5	38788	Power/Heat/High-Limit Light 125VAC		For 115VAC



Parts Model CF-400G

7 - 2 Rear View of Lower Cabinet

Item No.	Part No.	Description	No. Req'd	Remarks
1	32449	Fan 120 VAC Tapped		
1	32445	Fan 208/240 VAC Tapped		
2	23125	Igniter		
3	23150	Flame Sensor		
4	20250	Igniter Cable		
5	40300	Burner, Gas		
6	22975	Spark Ignition Module		
7	45108	Gas Control Valve (natural) (For LP see note 1)		
8	36456	Elevator Motor 115 VAC		
8	36457	Elevator Motor 208/240 VAC		
9	23175	Elevator Micro Switch		Not Shown
10	42600	Gas Cock		Not Shown
11	22925	Audiolarm/Non Ignition Alarm		Not Shown
12	22976	Audiolarm/Watlow		Not Shown
13	46752	Vacuum Line		
14	46734	Gas Burner Line		

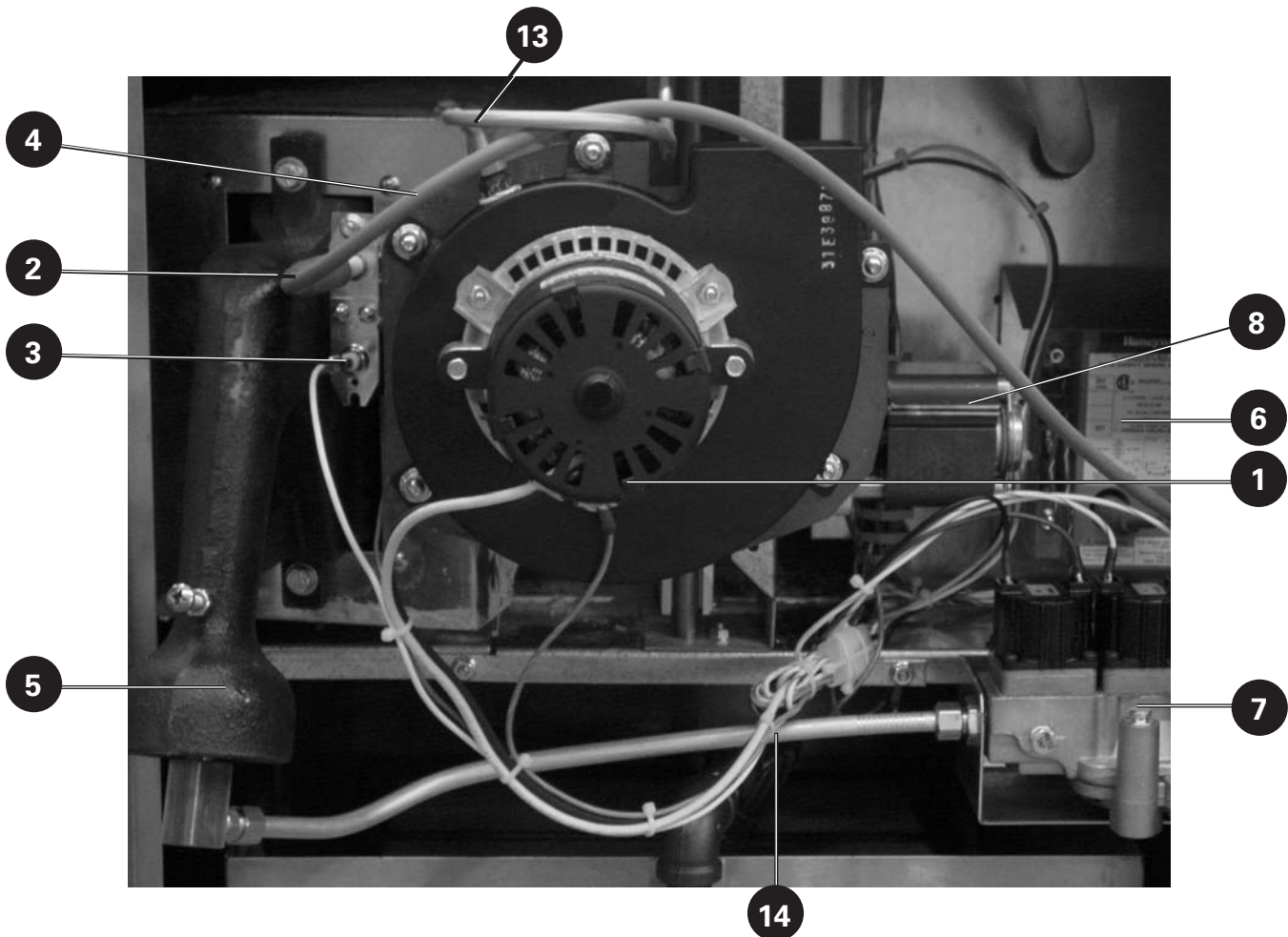

Note 1: LP requires conversion kit part number 45109

Parts Model CF-400G

7 - 3 Rear View of Header Section

Item No.	Part No.	Description	No. Req'd	Remarks
1	37616	Transformer 20 VA 120/208/240 VAC/Watlow	1	
2	23754	Thermostat 425°F (218°C) 208/240 VAC	1	
2	23749	Thermostat 425°F (218°C) (120 VAC)	1	
3	32227	Transformer 40VA 120 VAC	2	
3	30187	Transformer 40VA 208 or 240 VAC		
4	23000	Vacuum Switch (Rectangle in shape)		
5	43300	Hose, 34 - 1/4"		
6	23751	Terminal Block		
7	22976	Buzzer/Watlow Alarm		Not shown
8	70912	Pump Motor Assembly	1	
9	70910	Pump Only		
10	70911	Pump Motor Only	1	
11	22925	Buzzer Alarm (No Ignition Alarm)		
12	21950	Fuse Holder (Top of header, not shown)		Not shown
13	21900	Fuse (not shown)		

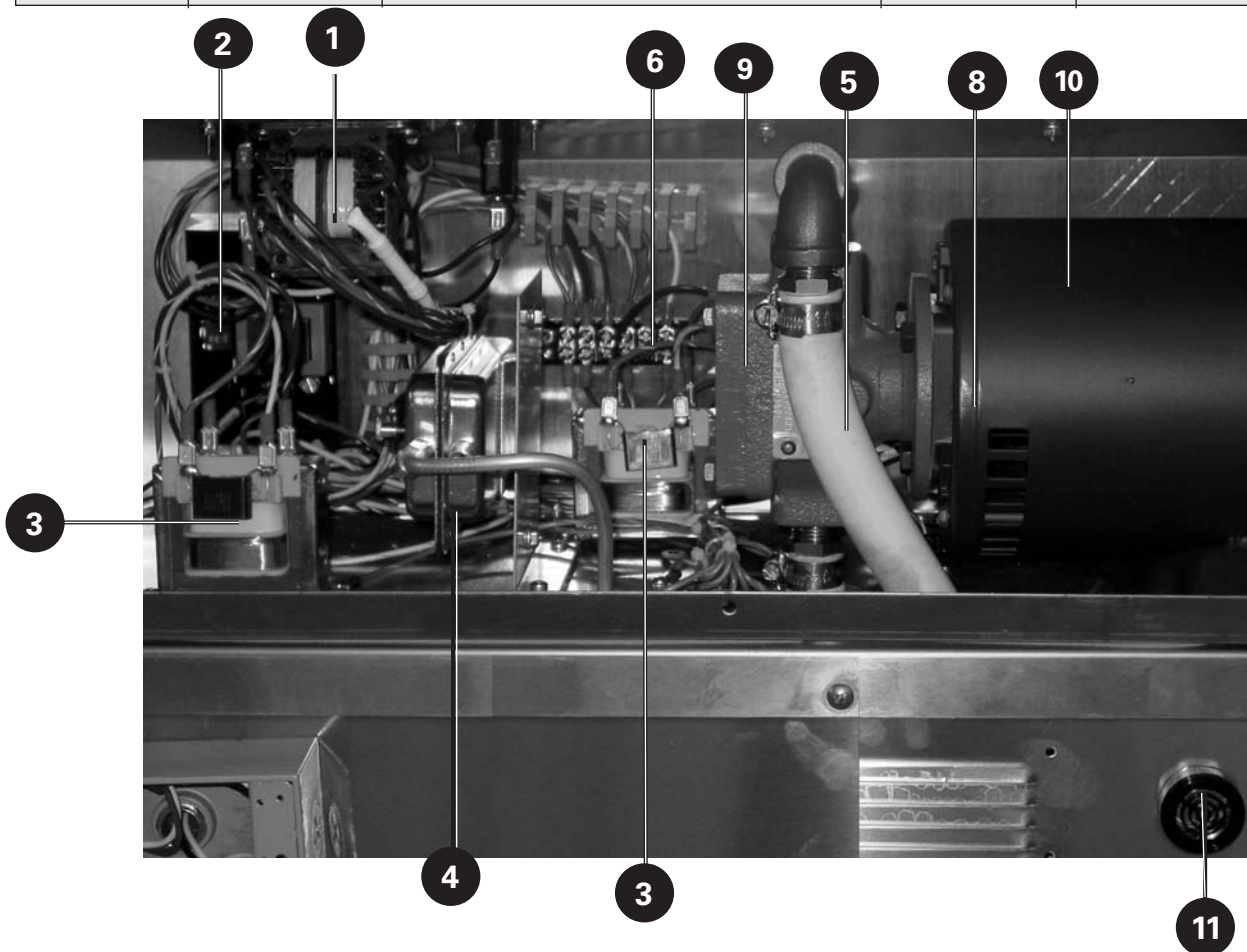

Parts Model CF-400G

7 - 4 Filter Pan Assembly

Item No.	Part No.	Description	No. Req'd	Remarks
1	43302	Hose Assembly		
2	44150	1½" (1.27cm) Brass Assembly/Male Quick Disconnect		
3	42250	Elbow, 1/2 NPT 90° STR Blk		
4	30040	Hold Down Frame		
5	54526	Hold Down Lever		
6	30040-4	Hold Down Frame Stud		
7	30039-8	Filter Pan Stud		
8	30076	Filter Pan Only		
9	30041	Filter Pan Screen		
10	41900	Coupling 1½" Brass/Female Quick Disconnect		Not Shown
11	42200	ELL, BLK, 1/2 N, 90 Deg.		

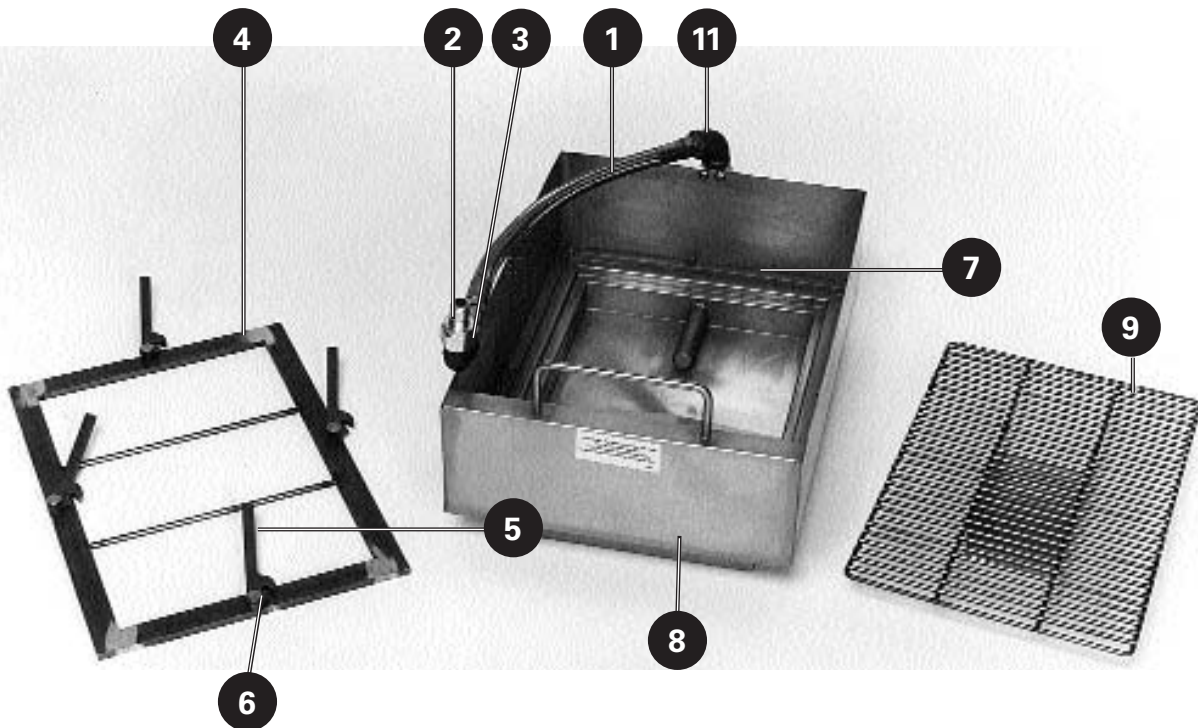

Wiring *Model CF-400G / Electro-Mechanical*

8 - 1 Model CF-400G 208/240/60/1

Item No.	Part No.	Description	No. Req'd	Remarks
1	20109	Switch, 170-CRD N.C. (Red BTN)	1	
2	23000	Assembly Vacuum Switch	1	
3	23754	Safety Board, 425°F	1	
4	23900	Probes: Safety & Variable Temperature	2	
5	21950	Fuse Holder w/15A Fuse (21900)	2	
6	23751	Terminal Block	2	
7	38217	Pilot Light (PWR/Heat/Hi-Limit)	1	
8	21190	Switch, Power (Rocker)	1	
9	20108	Timer, Cook	1	
10	21189	Switch, Selector (Rocker)	1	
11	21157	Microswitch, (Valve)	1	
12	70912	Pump	1	
13	21101	Socket, Relay	1	
14	21102	Relay, 8 Pin	1	
15	32445	Assembly, Exhaust Blower 60 Hz	1	
16	30187	Transformer	2	
17	45108	Valve, Gas	1	
18	22975	Module, Ignition (natural) (LP see note 1)	1	
19	23782	Sonalert	2	
20	70455	Setpot, 0-350° (Part of 20251)	1	
21		Thermostat, 0-350°, 208-240V	1	
22	25275	Wire Nut, Blue Small	6	
23	25200	Setpot Wire, Multi-Lead, Grey	1	
24	21196	Terminal Block Jumper	7	
25	21900	Fuse SC-15 Amp	2	

Note 1: LP requires conversion kit part number 45109

Wiring Model CF-400G / Electro-Mechanical

8 - 1 Model CF-400G 208/240/60/1

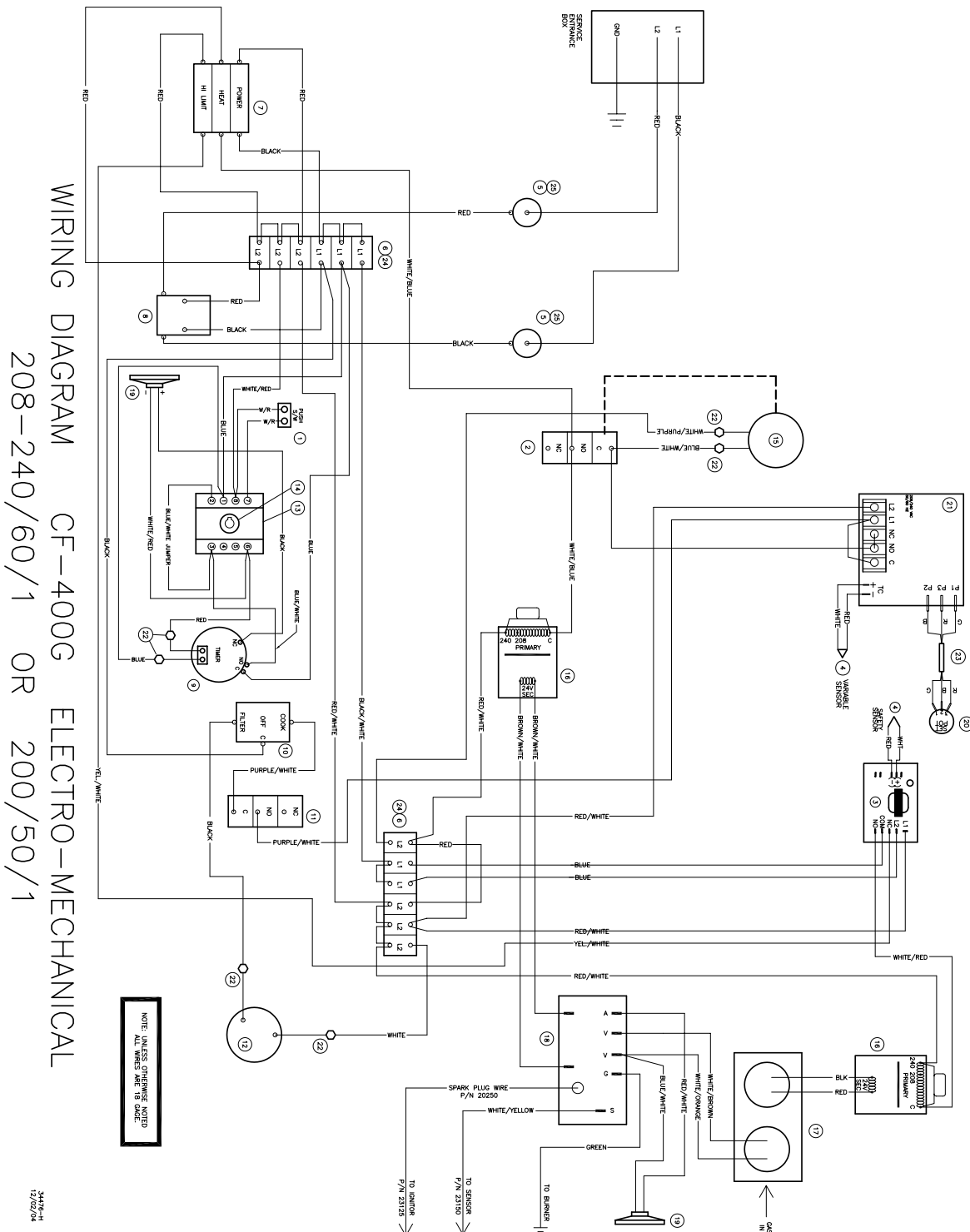

Wiring Model CF-400G / Computer

8 - 2 Model CF-400G 208/240/60/1

<i>Item No.</i>	<i>Part No.</i>	<i>Description</i>	<i>No. Req'd</i>	<i>Remarks</i>
1	22976	Sonalert	1	
2	23000	Assembly, Vacuum Switch	1	
3	23754	Safety Board, 425°F	1	
4	23900	Probes: Safety & Variable Temperature	1	
5	21950	Fuse Holder w/15 A Fuse (21900)	2	
6	23751	Terminal Block	2	
7	38217	Pilot Light (PWR/Heat/Hi-Limit)	1	
8	21190	Switch, Power (Rocker)	1	
9	24241	Computer Controller (Watlow)	1	
10	21189	Switch, Selector (Rocker)	1	
11	21157	Microswitch, (Valve)	1	
12	70912	Pump	1	
13	23175	Microswitch, Reed (Elevator)	1	
14	36457	Assembly, Elevator Motor	1	
15	37616	Transformer, Watlow, 24VAC	1	
16	32489	Assembly, Exhaust Blower 60 Hz	1	
17	30187	Transformer Assembly	2	
18	45108	Valve, Gas	1	
19	22975	Module, Ignition (natural) (LP see note 1)	1	
20	23782	Sonalert	1	
21	38365	Fuse	1	
22	25275	Wire Nut, Blue, Small	5	
23	20007	Connector With Male Pins	1	
24	20008	Connector With Female Pins	1	
25	21196	Terminal Block Jumper	7	
26	21900	Fuse SC-15 Amp		

Note 1: LP requires conversion kit part number 45109

Wiring Model CF-400G / Computer

8 - 2 Model CF-400G 208/240/60/1

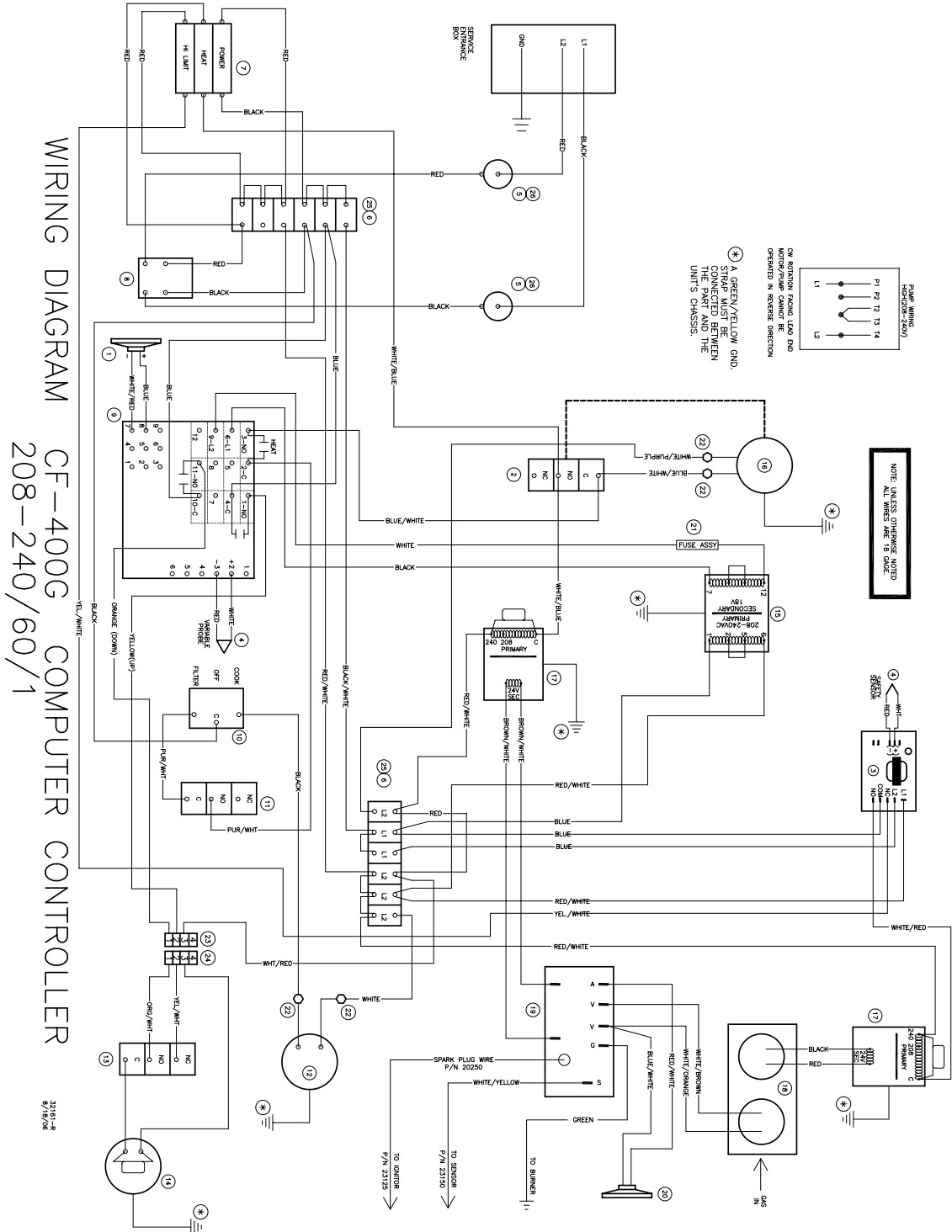

Wiring Model CF-400G - CE / Computer

8 - 3 Model CF-400G - CE 220/50/1 or 240/50/2

Item No.	Part No.	Description	No. Req'd	Remarks
1	23173	Reset Switch	1	
2	20187	Vacuum Switch (Dongs)	1	
3	20196	Safety Thermostat, 425°F	1	
4	23900	Probe, Variable Temperature	1	
5	21950	Fuse Holder W/15 AMP Fuses (21900)	2	
6	23751	Terminal Block	2	
7	20174	Pilot Light (PWR/Fail/Hi-Limit)	1	
8	21190	Switch, Power Rocker	1	
9	24241	Computer Controller (Watlow)	1	
10	21189	Switch, Selector Rocker	1	
11	21157	Microswitch, (Valve)	1	
12	76925	Pump	1	
13	23175	Microswitch, (Elevator)	1	
14	36457	Assembly, Elavator Motor	1	
15	20217	Transformer, 24VAC, 50Hz , CE	1	
16	32489	Assembly, Exhaust Blower 50 Hz	1	
17	20189	Valve, Gas	1	
18	20188	Module, Ignition (natural) (LP see note 1)	1	
19	22976	Sonalert	1	
20	21285	6 ft. Cord W/Plug - 18/3 SO	1	
21	25275	Wire Nut (Blue)	3	
22	20012	Fuse Holder W/1A Fuse (20013)	2	

Note 1: LP requires conversion kit part number 45109

Wiring Model CF-400G - CE / Computer

8 - 3 Model CF-400G - CE 220/50/1 or 240/50/2

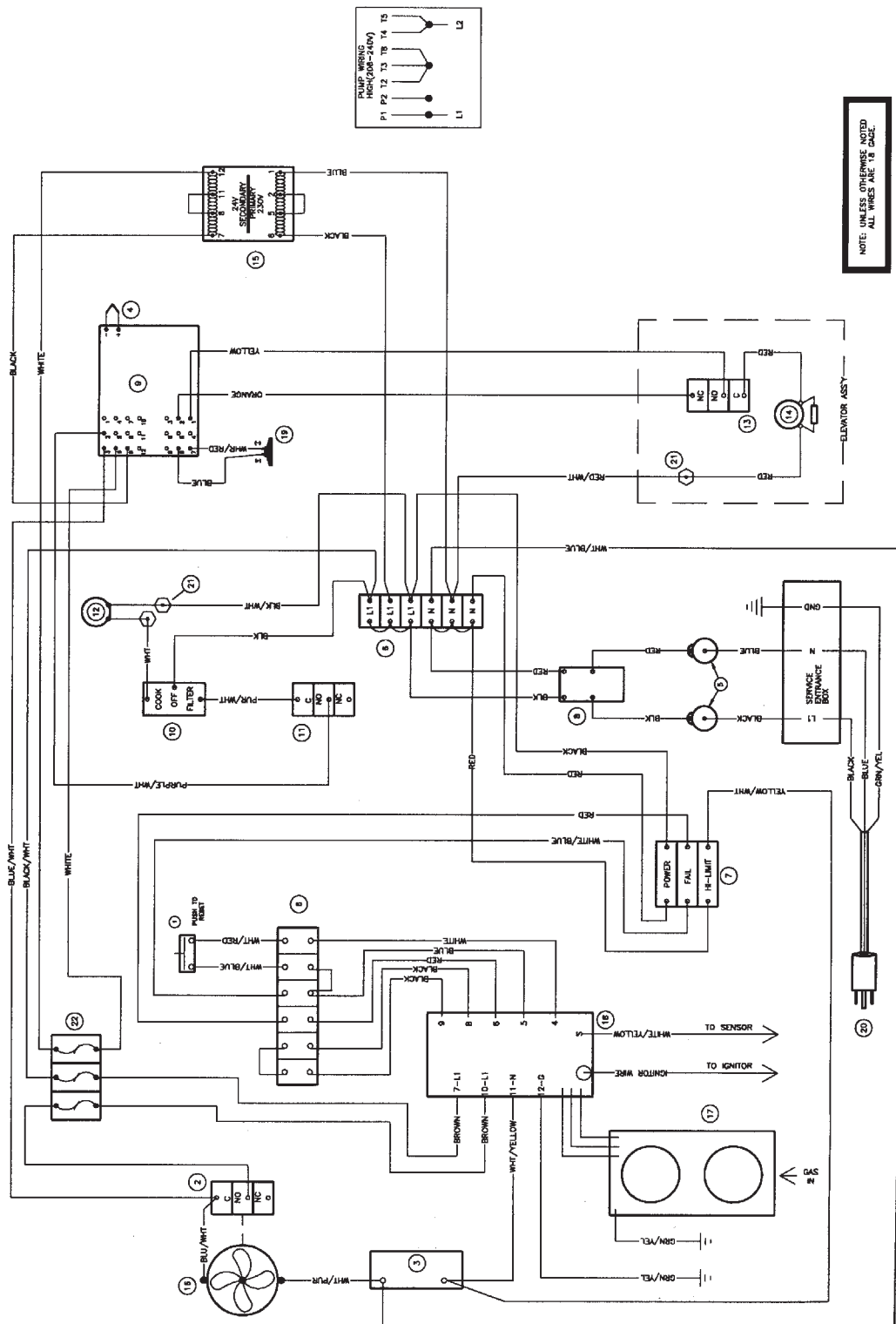

Wiring Model CF-400G / Computer

8 - 4 Wiring Diagram Model CF-400G 120/60/1

Item No.	Part No.	Description	No. Req'd	Remarks
1	22976	Sonalert	1	
2	23000	Vacuum Switch	1	
3	23749	Safety Board, 425°F	1	
4	23900	Probes: Safety & Variable Temperature	2	
5	21950	Fuse Holder W/15 AMP Fuse (21900)	2	
6	23751	Terminal Block	2	
7	38788	Pilot Light (PWR/Heat/Hi-Limit)	1	
8	21190	Switch Power Rocker	1	
9	24241	Computer Controller (Watlow)	1	
10	21189	Switch, Selector Rocker	1	
11	21157	Microswitch, (Valve)	1	
12	70912	Pump	1	
13	23175	Microswitch, Reed (Elevator)	1	
14	36456	Assembly, Elavator Motor	1	
15	37616	Transformer, Watlow, 120/24VAC	1	
16	32449	Assembly, Exhaust Blower 60 Hz	1	
17	32227	Transformer Assembly	2	
18	45108	Valve, Gas	1	
19	22975	Module, Ignition (natural) (LP see note 1)	1	
20	22925	Sonalert	1	
21	38635	Fuse Assembly	1	
22	25275	Wire Nut, Blue	5	
23	20007	Connector With Male Pins	1	
24	20008	Connector With Female Pins	1	
25	21196	Terminal Block Jumper	7	
26	21900	Fuse SC-15 Amp	2	
27	21285	Cordset W/ Plug	1	

Note 1: LP requires conversion kit part number 45109

Notes



Notes





Giles Enterprises, Inc.

An ISO9001 Registered Company

2750 Gunter Park Drive West • Montgomery, AL 36109 USA

Fax: (334) 272-3561 • Internet: www.gilesent.com

Service Hotline (Toll Free): 1-800-554-4537 (USA & Canada Only)

Form No. 60201 (Revised 01/04/07)