

---

# OWNER'S MANUAL

---



## IRHU Infra Red Holding Unit

U.S Patent 7105779, 7227102, 7328654  
Mexico MX245808, United Kingdom UK GB2396210, Taiwan TW I279507  
Other U.S. and Foreign Patents Pending

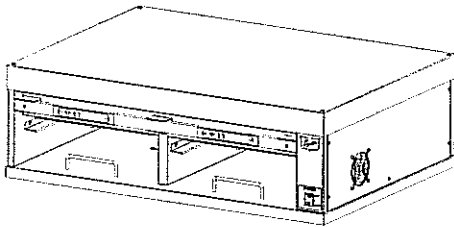

**IRHU-12**

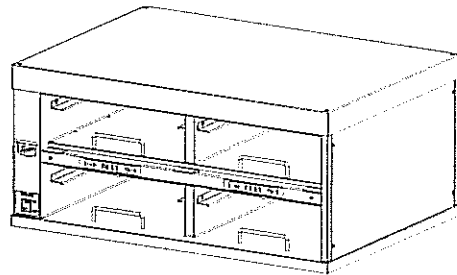

**IRHU-22**

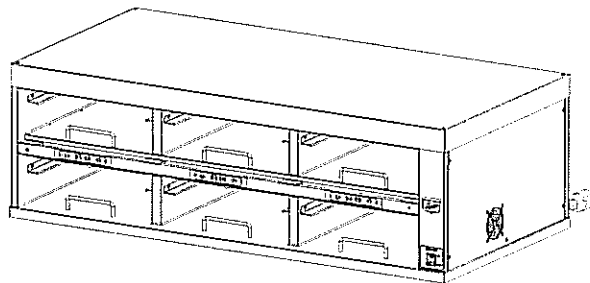

**IRHU-23**

**IMPORTANT INFORMATION  
READ BEFORE USE  
PLEASE SAVE THESE INSTRUCTIONS**



"Your Solutions Partner"

Duke Manufacturing Co.  
2305 N. Broadway • St. Louis, MO 63102  
800.735.3853 • 3.231.1130 • 314.231.5074 Fax  
[www.dukemfg.com](http://www.dukemfg.com)

159038 rev.L

# CONTENTS

Manufacturing Introduction.....	2
Safety Instruction.....	3
Spec Sheets.....	4-6
Main Features.....	7
Installation Instructions.....	8-9
Operating Instructions.....	10-11
Cleaning and Care.....	12
Troubleshooting.....	13
Parts List and Illustration.....	14-15
Wiring Diagrams.....	16-18
Customer Assistance.....	19

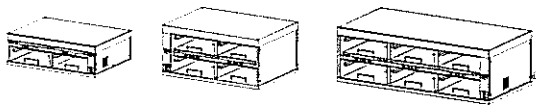

## Manufacturer's Introduction

The Duke IR Holding Unit was developed in response to the need for extended food-holding capabilities to provide consistently high, "just cooked" food quality.

The Duke IR Holding Unit utilizes Duke's patented "Infra Red" holding technology that provides even heat distribution to food pans. This allows fried foods to be held for extended periods without noticeable degradation of quality, reducing food scrap/waste.

The self contained, individually formed, sealed compartments of the Duke IR Holding Unit eliminate food odor and taste transfer. Because the compartments are sealed, no disassembly is required for cleaning and product changes.

The unique design of the Duke IR Holding Unit allows the IR energy to be programmed for each compartment. The holding profile is preset at the factory. This reduces the likelihood of inconsistent performance between restaurant locations.

Supplier Name: Duke Manufacturing Co.  
 Address: 2305 N. Broadway  
 St. Louis, MO 63102

Model #:	IRHU-12xxxx-208
	IRHU-12xxxx-230
	IRHU-12xxxx-240
Note: "xxxx" denotes programming code	IRHU-22xxxx-208
	IRHU-22xxxx-230
	IRHU-22xxxx-240
	IRHU-23xxxx-208
	IRHU-23xxxx-230
	IRHU-23xxxx-240

Serial #: \_\_\_\_\_

Date Received: \_\_\_\_\_

Date Installed: \_\_\_\_\_

Telephone: (800) 735-DUKE (3853)  
 (314) 231-1130

Fax: (314) 231-5074

Service Referral #: \_\_\_\_\_

Local Service Name: \_\_\_\_\_

Local Service #: \_\_\_\_\_



## IMPORTANT SAFETY INSTRUCTIONS

Throughout this manual, you will find the following safety words and symbols that signify important safety issues with regards to operating or maintaining the equipment.

### WARNING

**GENERAL WARNING.** Indicates information important to the proper operation of the equipment. Failure to observe may result in damage to the equipment and/or severe bodily injury or death.

### WARNING

**ELECTRICAL WARNING.** Indicates information relating to possible shock hazard. Failure to observe may result in damage to the equipment and/or severe bodily injury or death.

### CAUTION

**GENERAL CAUTION.** Indicates information important to the proper operation of the equipment. Failure to observe may result in damage to the equipment.

### WARNING

**HOT SURFACE WARNING.** Indicates information important to the handling of equipment and parts. Failure to observe caution could result in personal injury.

In addition to the warnings and cautions in this manual, use the following guidelines for safe operation of the unit.

- Read all instructions before using equipment.
- For your safety, the equipment is furnished with a properly grounded cord connector. Do not attempt to defeat the grounded connector.
- Install or locate the equipment only for its intended use as described in this manual. Do not use corrosive chemicals in this equipment.
- Do not operate this equipment if it has a damaged cord or plug, if it is not working properly, or if it has been damaged or dropped.
- This equipment should be serviced by qualified personnel only. Contact the nearest Duke authorized service facility for adjustment or repair.
- Do not block or cover any openings on the unit.
- Do not immerse cord or plug in water.
- Keep cord away from heated surfaces.
- Do not allow cord to hang over edge of table or counter.
- Inspect glass daily for chips, cracks, or breaking. Discard all food and notify manager

if any chips, cracks, or broken glass are found. Do not use equipment. All glass must be in good condition before using equipment to hold food.

The following warnings and cautions appear throughout this manual and should be carefully observed.

- Turn the unit off, disconnect the power source and allow unit to cool down before performing any service or maintenance on the unit.
- The procedures in this manual may include the use of chemical products. You must read the Material Safety Data Sheets before using any of these products.
- The unit should be grounded according to local electrical codes to prevent the possibility of electrical shock. It requires a grounded receptacle with separate electrical lines, protected by fuses or circuit breaker of the proper rating.
- Disposal of the unit must be in accordance with local environmental codes and/or any other applicable codes.

## SAVE THESE INSTRUCTIONS



"Your Solutions Partner"

Duke Manufacturing Co.  
2305 N. Broadway • St. Louis, MO 63102  
800.735.3853 • 3.231.1130 • 314.231.5074 Fax  
www.dukemfg.com

Page 3 of 20

# SPEC SHEET

## Model IRHU-12

<b>Shipping Weight:</b>	90 lbs/41 Kg	
<b>Electrical</b>	IRHU-12xxx-208	208 V, 6.5 A, 1350 W, 50/60 Hz
	IRHU-12xxx-230	230 V, 5.9 A, 1350 W, 50/60 Hz
	IRHU-12xxx-240	240 V, 5.6 A, 1350 W, 50/60 Hz

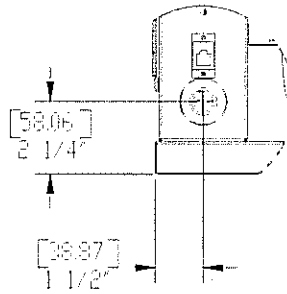
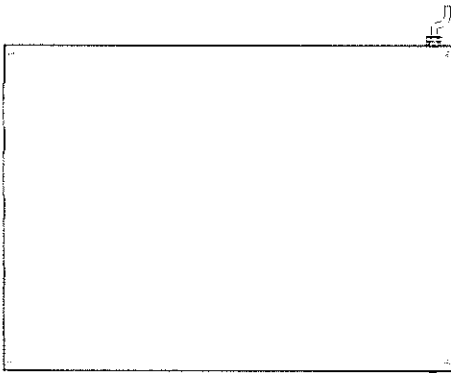
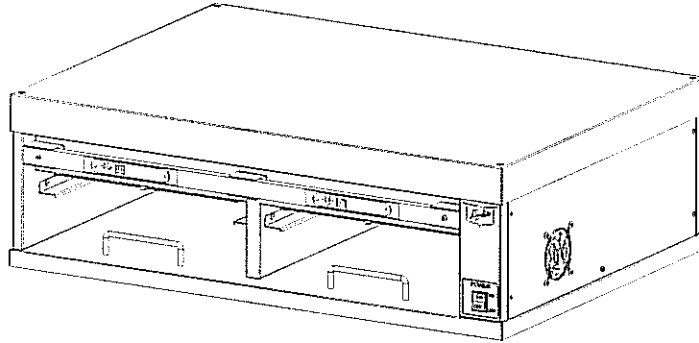

L6-20P  
Twist Lock Plug



CEE 7/7  
"Schuko" Plug

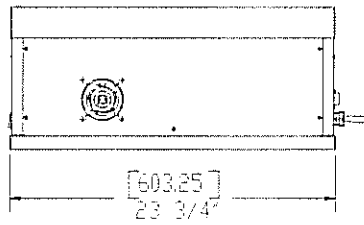
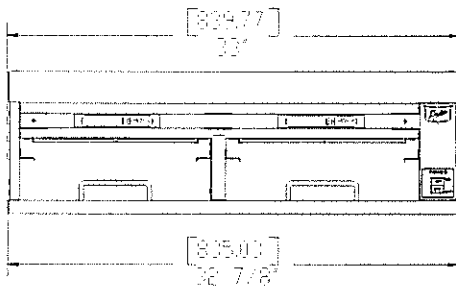

ALSO CLASSIFIED BY  
UNDERWRITERS LABORATORIES INC.  
IN ACCORDANCE WITH  
NSF NO. 4 1999



"Your Solutions Partner"

Duke Manufacturing Co.  
2305 N. Broadway • St. Louis, MO 63102  
800.735.3853 • 3.231.1130 • 314.231.5074 Fax  
www.dukemfg.com

# SPEC SHEET

## Model IRHU-22

<b>Shipping Weight:</b>	170 lbs/79 Kg	
<b>Electrical</b>	IRHU-22xxx-208	208 V, 13 A, 2700 W, 50/60 Hz
	IRHU-22xxx-230	230 V, 11.7 A, 2700 W, 50/60 Hz
	IRHU-22xxx-240	240 V, 11.3 A, 2700 W, 50/60 Hz

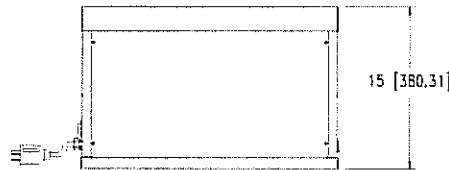
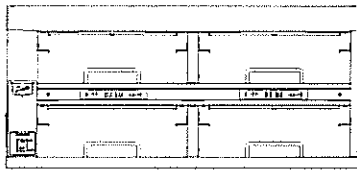
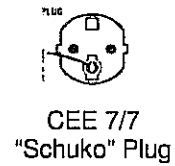
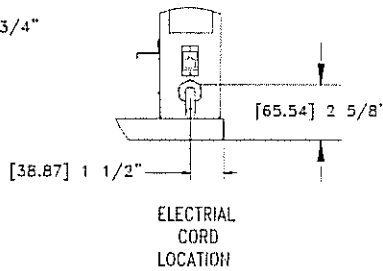
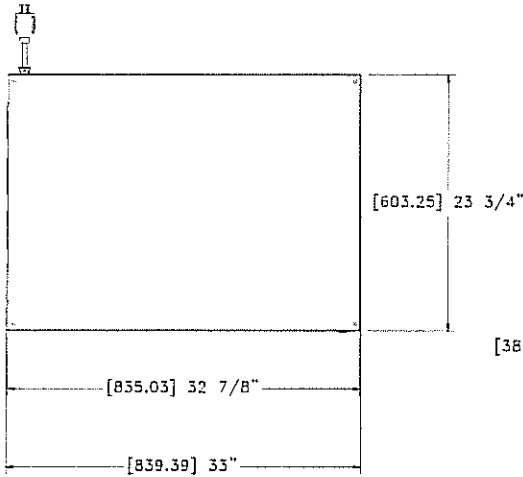
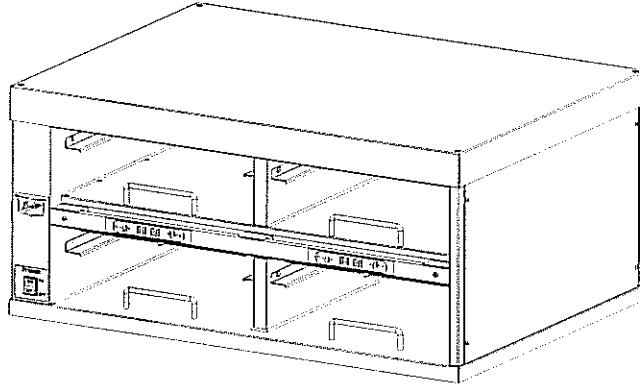

ALSO CLASSIFIED BY  
UNDERWRITERS LABORATORIES INC.  
IN ACCORDANCE WITH  
NSF NO. 4 1999



"Your Solutions Partner"

Duke Manufacturing Co.  
2305 N. Broadway • St. Louis, MO 63102  
800.735.3853 • 3.231.1130 • 314.231.5074 Fax  
www.dukemfg.com

# SPEC SHEET

## Model IRHU-23

<b>Shipping Weight:</b>	245 lbs/111 Kg	
<b>Electrical</b>	IRHU-23xxx-208	208 V, 19.5 A, 4050 W, 50/60 Hz
	IRHU-23xxx-230	230 V, 17.6 A, 4050 W, 50/60 Hz
	IRHU-23xxx-240	240 V, 16.9 A, 4050 W, 50/60 Hz

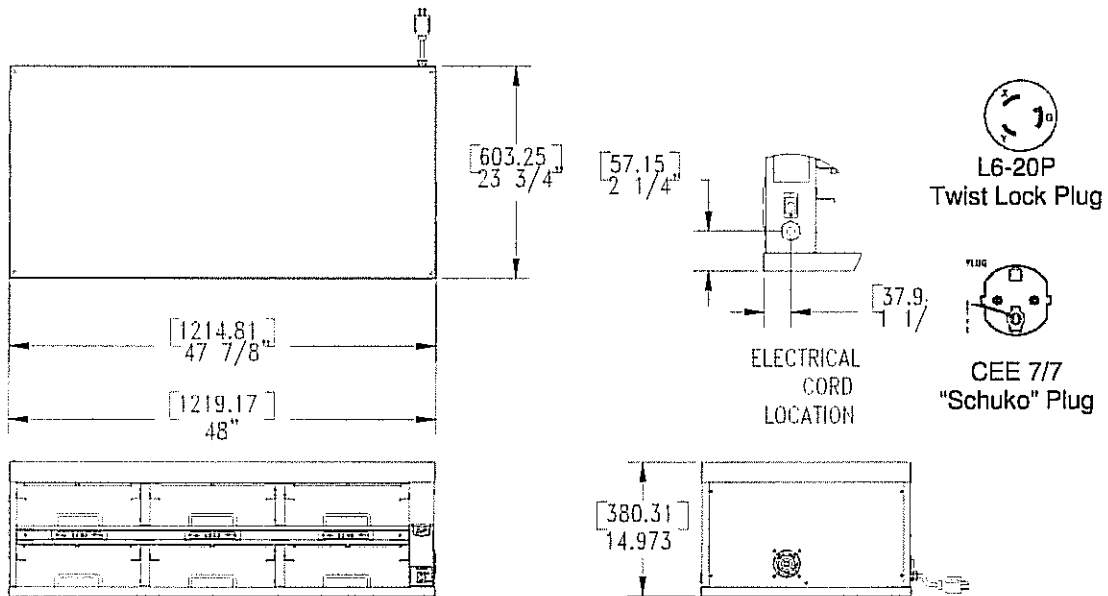
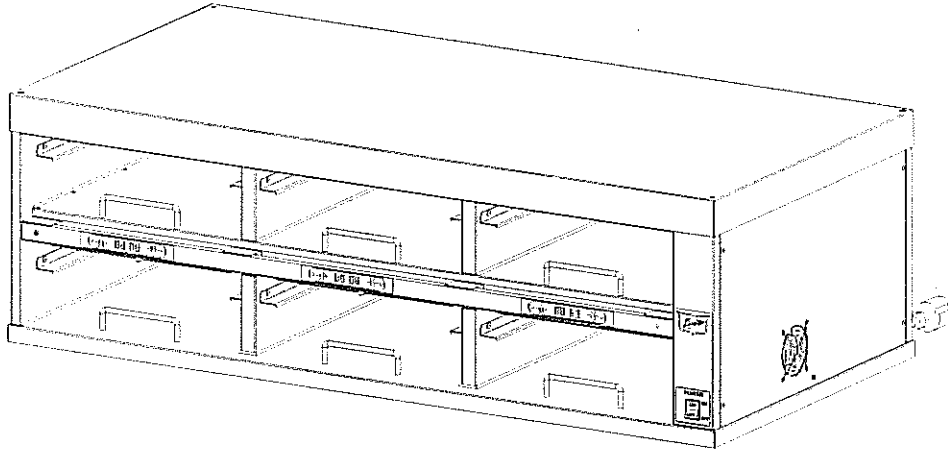

ALSO CLASSIFIED BY  
 UNDERWRITERS LABORATORIES INC.  
 IN ACCORDANCE WITH  
 NSF NO. 4 1999



"Your Solutions Partner"

Duke Manufacturing Co.  
 2305 N. Broadway • St. Louis, MO 63102  
 800.735.3853 • 3.231.1130 • 314.231.5074 Fax  
[www.dukemfg.com](http://www.dukemfg.com)

# MAIN FEATURES

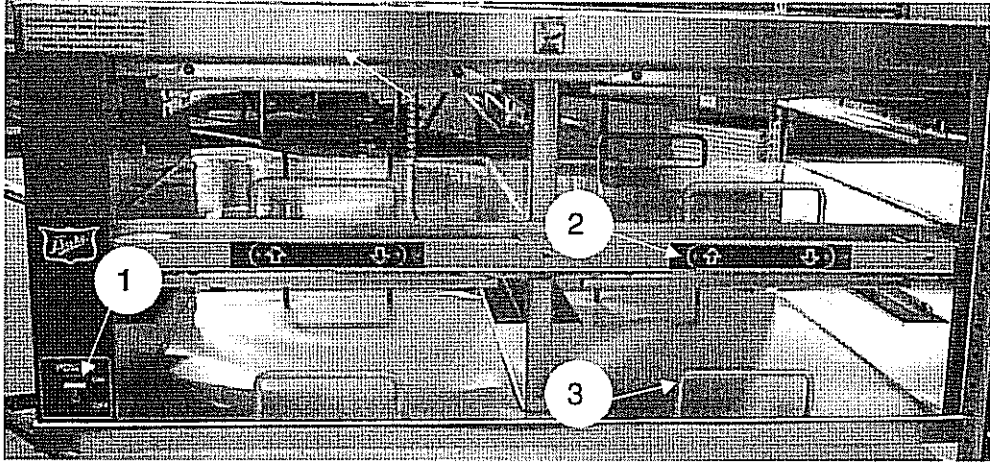

1. ON/OFF SWITCH
2. DIGITAL PAN TIMER KEYBOARD

3. PAN STOP (NOTE: Other units have a different style of Pan Stop.)

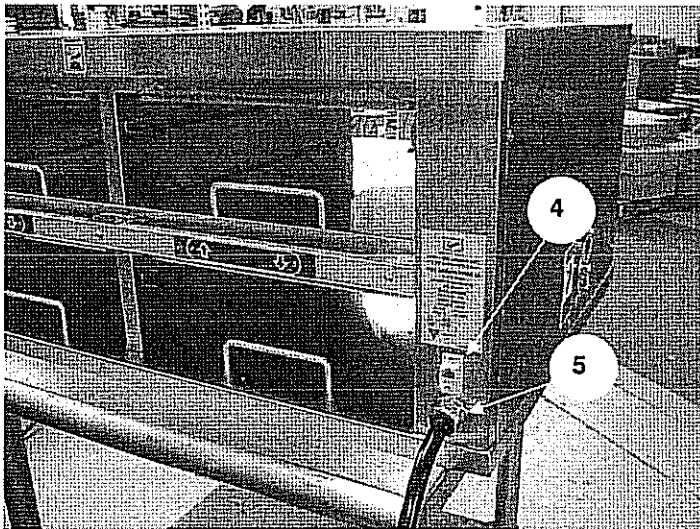

4. PROGRAMMING CONNECTION
5. POWER CORD



"Your Solutions Partner"

Duke Manufacturing Co.  
2305 N. Broadway • St. Louis, MO 63102  
800.735.3853 • 3.231.1130 • 314.231.5074 Fax  
[www.dukemfg.com](http://www.dukemfg.com)

# INSTALLATION

## Unpacking Unit

- Inspect the shipping carton and/or container, carefully noting any exterior damage on the delivery receipt, which was not evident on the outside of the shipping container (concealed damage). Contact the carrier immediately and file a damage claim with them. Save all packing materials when filing a claim. Freight damage claims are the responsibility of the purchaser and are not covered by the warranty.
- Inspect unit for damage such as, broken glass, etc.
- Report any dents or breakage to source of purchase immediately.
- **Do not attempt to use unit if damaged.**
- Remove all materials from unit interior.
- If unit has been stored in extremely cold area, wait a few hours before connecting power.

## Unit Placement

- Do not install unit next to or above source of heat, such as oven or deep fat fryer.
- Install unit on level countertop surface.
- Outlet should be located so that plug is accessible when the unit is in place.
- The following minimum clearances must be maintained between the warmer and any combustible or non-combustible substance:

Unit	Clearance
Right Side	0"
Left Side	0"
Rear	8"
Floor	0"

Proper airflow around unit will cool the electrical components. With restricted airflow, the unit may not operate properly and the life of the electrical parts may be reduced.

## ⚠ WARNING ⚠

To avoid risk of electrical shock or death, this unit must be grounded and plug must not be altered.

## Earthing Instructions

### Unit **MUST** be grounded.



Grounding reduces risk of electric shock by providing an escape wire for the electric current if an electrical short

occurs. This unit is equipped with a cord having a grounding wire with a grounding plug. The plug must be plugged into an outlet that is properly installed and grounded.

Consult a qualified electrician or servicer if grounding instructions are not completely understood, or if doubt exists as to whether the oven is properly grounded.

**Do not use an extension cord.** If the product power cord is too short, have a qualified electrician install a three-slot receptacle. This unit should be plugged into a separate circuit with the electrical rating as provided in product specifications.

### External Equipotential Earthing Terminal (export only)

Equipment has secondary earthing terminal.

Terminal provides external earthing connection used in addition to earthing prong on plug. Located on outside of oven back, terminal is marked with this symbol.



"Your Solutions Partner"

Duke Manufacturing Co.  
2305 N. Broadway • St. Louis, MO 63102  
800.735.3853 • 3.231.1130 • 314.231.5074 Fax  
www.dukemfg.com

Page 8 of 20

# INSTALLATION

The digital pan timers count down in increments of one minute. The table below lists the display appearance corresponding to the actual hold time.

**TABLE 1 - DIGITAL TIMER DISPLAYS**

ACTUAL TIME (min.)	DISPLAY TIME
0-59	00-59
60-119	1H
120-179	2H
180-239	3H
240	4H
270	4H
300	5H
330	5H
360	6H
390	6H
420	7H
450	7H
480	8H
510	8H
540	9H
570	9H



"Your Solutions Partner"

Duke Manufacturing Co.  
2305 N. Broadway • St. Louis, MO 63102  
800.735.3853 • 3.231.1130 • 314.231.5074 Fax  
[www.dukemfg.com](http://www.dukemfg.com)

# OPERATING INSTRUCTIONS

**NOTE:** Before you start, turn off the power to the Warmer, and then back on. All the lights should be RED.

**NOTE:** Always stand on the front side of the warmer facing the ON/OFF switch.

## 1) Enter Programming Mode

Press and hold for 5 seconds the 2 keys closest to the ON/OFF switch.

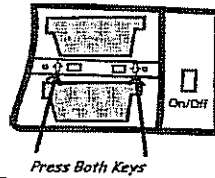

1 solid RED light will turn on.  
The 2 displays will show numbers.  
All other displays will go out.

## 2) Select and View Settings

The solid RED light indicates the selected pan.  
The left display shows the setting number  
The right display shows the value

### To change the setting number:

Press the arrow keys on the left display.  
View the values on the right display:

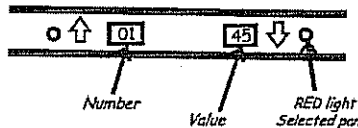

## Settings:

1=Hold Time	5=Phase 2 Time	9=Phase 4 Enabled
2=Cook Time	6=Phase 2 %Heat	10=Linking
3=Phase 1 Time	7=Phase 3 Time	11=Copying
4=Phase 1 %Heat	8=Phase 3%Heat	

## 3) Enter and Exit Edit Mode

To enter edit mode press and hold the DOWN arrow key for 3 seconds – the solid RED LED will blink.

To exit edit mode press and hold the DOWN arrow key for 3 seconds – The blinking RED LED will turn solid.

## 4) Edit Settings 1-8

Select the settings to be changed then enter edit mode. Use the UP DOWN arrow keys to change the value.

NOTE: FF = Phase at 100%  
9 = Phase 4 Enable/Disable  
Enabled = - -  
Disabled = 00

Exit edit mode

## 5) Edit Linking – Setting 10

Select Setting 10, then enter edit mode.  
The RED light indicates the selected pan.  
The GREEN lights = Pans linked to the selected pan.

The OFF lights = Pans not linked to the selected pan.

Press any arrow key to turn the GREEN lights off.

Exit edit mode.

## 6) Copy – Settings 11

Copies the selected pan's values to another pan.

Select setting 11, then enter edit mode.

The blinking RED light indicates the selected pan.

The GREEN lights = pans that already have the same values.

The OFF lights = pans that have different values.

To copy the selected pan, press any arrow key.

The OFF light will turn YELLOW marking that pan to be copied.

Any YELLOW light may be pressed again to unmark that pan.

Exit edit mode to complete the copy.

## 7) Select Another Pan.

To select the top pan or bottom pan press both arrow keys together.

The solid RED light will switch to the other pan.

To select another pair of pans press both arrow keys by that pair. The numbers will light and the solid red light will move to the bottom of that pair.



## 8) Exit Programming Mode

Review all settings as in step 2.

Turn off the power to the unit and then back on – the unit will be in the normal operation mode.



"Your Solutions Partner"

Duke Manufacturing Co.  
2305 N. Broadway • St. Louis, MO 63102  
800.735.3853 • 3.231.1130 • 314.231.5074 Fax  
www.dukemfg.com

Page 10 of 20

# OPERATING INSTRUCTIONS

**NOTE:** Before you start, turn off the power to the Warmer, and then back on. All the lights should be RED.

**NOTE:** Always stand on the front side of the warmer facing the ON/OFF switch.

## 1) Enter Setup Mode

Turn the power off.  
Then while powering on press and hold the 2 keys closest to the ON/OFF switch.

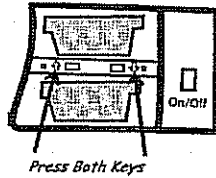

1 solid RED light will turn on.  
The 2 displays will show numbers.  
All other displays will go out.

## 2) Select and View Settings

The left display shows the setting number  
The right display shows the value

### To change the setting number:

Press the arrow keys on the left display.  
View the values on the right display.

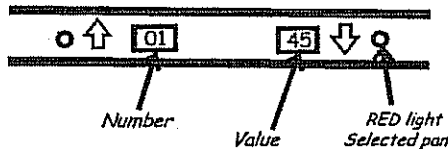

### Settings:

#### Setting # 99 – Duty Cycle Length

Do Not Change. Factory set at 06  
03 = 30 seconds  
06 = 60 seconds  
12 = 120 seconds.

#### Setting # 98 – Phase 4 On - % Heat

Do Not Change. Factory set at 30  
0 to 99, and FF = 100%

#### Setting # 97 – Active Keyboards

01 – Back Only, 02 – Front Only (1X2 & 1X3)  
01 – Front Only, 02 – Back Only (2x2)  
03 – Both Front and Back Active

#### Setting # 96 – Firmware Revision

Displays firmware version

#### Setting # 95 – Max Temperature

Displays the max electrical compartment temperature in °C (00 Resets to 0°C)

#### Setting # 94 – Actual Temperature

Displays the actual electrical compartment temperature in °C.

#### Setting # 93 – IR unit holding type

Change in edit mode to override until the next power up.

#### Setting # 92 – Current Monitor

Do Not Change. Factory Set at 01.  
01 – Current monitoring  
00 – No current monitoring  
(until power off)

#### Setting # 91 – Reset to factory default

01 – Reset

#### Setting # 90 – Jumper Installed

Change in edit mode to override until the next power up.

#### Setting # 89 – Factory Setting

Do Not Change.

#### Setting # 88 – Factory Setting

Do Not Change. (This setting does not exist in some programming.)

## 3) Enter and Exit Edit Mode

**To enter edit mode** press and hold the DOWN arrow key for 3 seconds – the solid RED LED will blink.

**To exit edit mode** press and hold the DOWN arrow key for 3 seconds – the blinking RED LED will turn solid.

## 4) Edit Settings 99-90

Select the settings to be changed then enter edit mode.

Use the UP and DOWN arrow keys to change the value.

## 5) Exit Setup Mode

Press and hold the 2 keys closest to the ON/OFF switch for 5 seconds to enter normal mode.



"Your Solutions Partner"

Duke Manufacturing Co.  
2305 N. Broadway • St. Louis, MO 63102  
800.735.3853 • 3.231.1130 • 314.231.5074 Fax  
www.dukemfg.com

Page 11 of 20

## CARE AND CLEANING

### WARNING

Bottom and sides of warmer wells are very hot and cool slowly.

### DANGER GLASS

Inspect glass daily for chips, cracks, or breaking. Discard all food and notify manager if any chips, cracks, or broken glass are found. Do not use equipment. All glass must be in good condition before using equipment to hold food.

### CAUTION

Electrical shock hazard. Do not wash with water jet or hose. Do not use caustic cleaners, acids, ammonia products, abrasive cleaners, or abrasive cloths. These can damage the stainless steel and plastic surfaces.

## Cleaning Guide and Checklist

### Daily

#### Supplies

YELLOW™ Dish soap Concentrate or LIQUID STORM™ Power Wash Detergent  
KAY @ SINK SANITIZER or KAYQUAT™ Sanitizer EXCEED® Multi-Surface & Glass Cleaner  
Clean, sanitizer-soaked towels

#### Procedure

### IMPORTANT!

Use clean, sanitizer-soaked towels (Important: towels must be wrung out so that they are damp and not dripping, dripping towels may harm the unit.)

1. Turn unit off and allow cooling for 10 minutes.
2. Remove all holding pans and wash, rinse and sanitize at the 3-compartment sink. Allow to air dry.
3. Spray a sanitizer-soaked towel with an EXCEED solution and wipe out all compartment on the holding unit. Wipe top compartments first and then lower compartments.

**NOTE: Never spray cleaning solution directly onto the cabinet.**

4. Spray a sanitizer-soaked towel with an EXCEED solution and wipe all glass surfaces covering the heating element in each compartment.
5. Spray a sanitizer-soaked towel with EXCEED solution and wipe the exterior of the cabinet.
6. Wipe out all the cleaned compartments with a clean dampened food service towel.
7. Spray a clean sanitizer-soaked towel with sanitizer solution and wipe out all cleaned compartments in the units.

### Inspection Checklist:

- Inspect glass for chips, cracks, or breaking.
- Unit is free of any visible food soils.
- Unit is free of grease or soils in holding compartment.
- Exterior of unit is free of smudges or soil.
- Holding pans are free of any food soil residue.
- Pans are free of damage such as cracks.



"Your Solutions Partner"

Duke Manufacturing Co.  
2305 N. Broadway • St. Louis, MO 63102  
800.735.3853 • 3.231.1130 • 314.231.5074 Fax  
www.dukemfg.com

Page 12 of 20

# TROUBLESHOOTING

## Testing and Troubleshooting Guide

### Pan Status Keyboard Test:

- a. Press a pan button once. The corresponding light turns green. Press the same button again. The corresponding light turns red. Repeat for every button on all keyboards.

#### Troubleshooting:

1. If the light turns red, and then turns off, the HOLD time is equal to 0. Program a new duration for at least one of the PHASEs for that pan.
2. If the Keyboard test fails, plug the keyboard into a different Warmer jack on the Station Unit and repeat the test on that keyboard. If the keyboard continues to fail the test, the keyboard is suspect. If the keyboard passes the test when plugged into a different Warmer jack, the Station Unit is suspect.

### Station Interface Unit Power:

- a. Power up the Warmer unit.
- b. Observe that the keyboard lights illuminate yellow, then red or go out depending on the programmed hold times.

#### Troubleshooting:

1. Check that the Warmer control powers up and the Warmer heats up.  
If not, call Duke Mfg. for Warmer service at 314-231-1130 or 800-735-3853.

### Service Hot-Line:

If you believe that you have a **Product Quality Timer System** service issue, perform the steps outlined above. If a test fails, perform the troubleshooting steps to see if this resolves the problem. Continue the remainder of the testing, if possible, to uncover any additional problems and document the symptoms and results. Please have this data handy before calling the Duke troubleshooting Hot Line listed above. **For optimum support, please be near the suspect units with a cordless phone, if available, when calling our Technicians.**

### **IMPORTANT**

Standard control location is at the right hand side on models IRHU-12 and IRHU-23. The IRHU-22 was designed to have the control location at the left hand side making the connection of the keyboard into the control board in reverse, i.e. Front keyboard plugs into the "BACK" at control board and back keyboard plugs into the "FRONT" at the control board.



# PARTS LIST AND ILLUSTRATIONS

Locator	P/N	Description	Quantity Per Unit		
			IRHU-12	IRHU-22	IRHU-23
1	159243	Cord, Power 20 Amp 250V – 208-240V units	1	1	
	159142	Cord, Power 30 Amp 250V – 208-240V Units			1
	159157	Cord Set, 16 Amp 230V CE – 230V Units	1	1	
	159161	Cord, HO7RN 3x2.5 MM2 – 230V Units			1**
	159158	Plug, Pin & Sleeve, 32Amp, 3-Pole, 230V			1
2	155749	Transformer, 208/240-12V – 208/240V Unit	1	1	1
	156838	Transformer, 230-12V – 230V Unit	1	1	1
3	159138	Gasket, Silicone Foam, .25x.125x12.0	4	8	12
4	159139	Gasket, Silicone Foam, .25x.125x19.0	4	8	12
5	156617	Coupler, Straight 8x8 RJ45	1	1	1
6	156667*	Cable, Program w/RJ45*	1	1	1
7	159072	Lamp, 70V 225W – 208V Unit	6	12	18
	159152	Lamp, 77V 225W – 230V Unit	6	12	18
	159124	Lamp, 80V 225W – 240V Unit	6	12	18
8	159149	Block, Terminal, 2 Bar 8-Tab with fuse holder	1	1	1
9	159077	Relay, Mini, FS24D20-06	2	4	6
10	600143	Kit, IRHU Control, Ver. 13	1	1	1
	600145	Kit, IRHU Control, Ver. 16	1	1	1
11	159080	Current Sensor with Connectors	2	2	2
12	159140	Screw, Captive, PNL 8-32x3/8"	4	8	12
13	159084	Switch, Lighted, DPST On-Off 20 AMP	1	1	1
14	159087	Thermostat, 180F with Reset	1	1	1
15	159120	Keyboard, Control 1x2 Front	1		
	159122	Keyboard, Control 1x2 Back	1		
	159088	Keyboard, Control 2x2		2	
	159089	Keyboard, Control 2x3			2
16	159090	Glass, Tempered, 19-1/2 x 12 x 1/4	2	4	6
17	159092	Fan, Muffin, 80mmx80mmx38mm	1	1	1
18	159026	Bracket, Glass Mount	2	4	6
19	159151*	Fuse, 20 Amp, Buckmann BK/AGC-20	2	2	2
20	159104	Thermostat, 400F, Auto Reset	1	2	4
21	159105	Thermostat, 425F, Auto Reset	1	2	4
22	512840	Terminal Block, 3-Position	1	1	1
23	512956	Guard, Fan	1	1	1
24	159158*	Plug, Pin/Sleeve, 32 Amp – 230V Unit			1**
25	159091	Pan Stop as shown	4	8	12
	159177	Pan Stop (not shown)	4	8	12

\*Note: Not Shown

\*\*Requires Plug



"Your Solutions Partner"

Duke Manufacturing Co.  
2305 N. Broadway • St. Louis, MO 63102  
800.735.3853 • 3.231.1130 • 314.231.5074 Fax  
www.dukemfg.com

Page 14 of 20

# PARTS LIST AND ILLUSTRATIONS

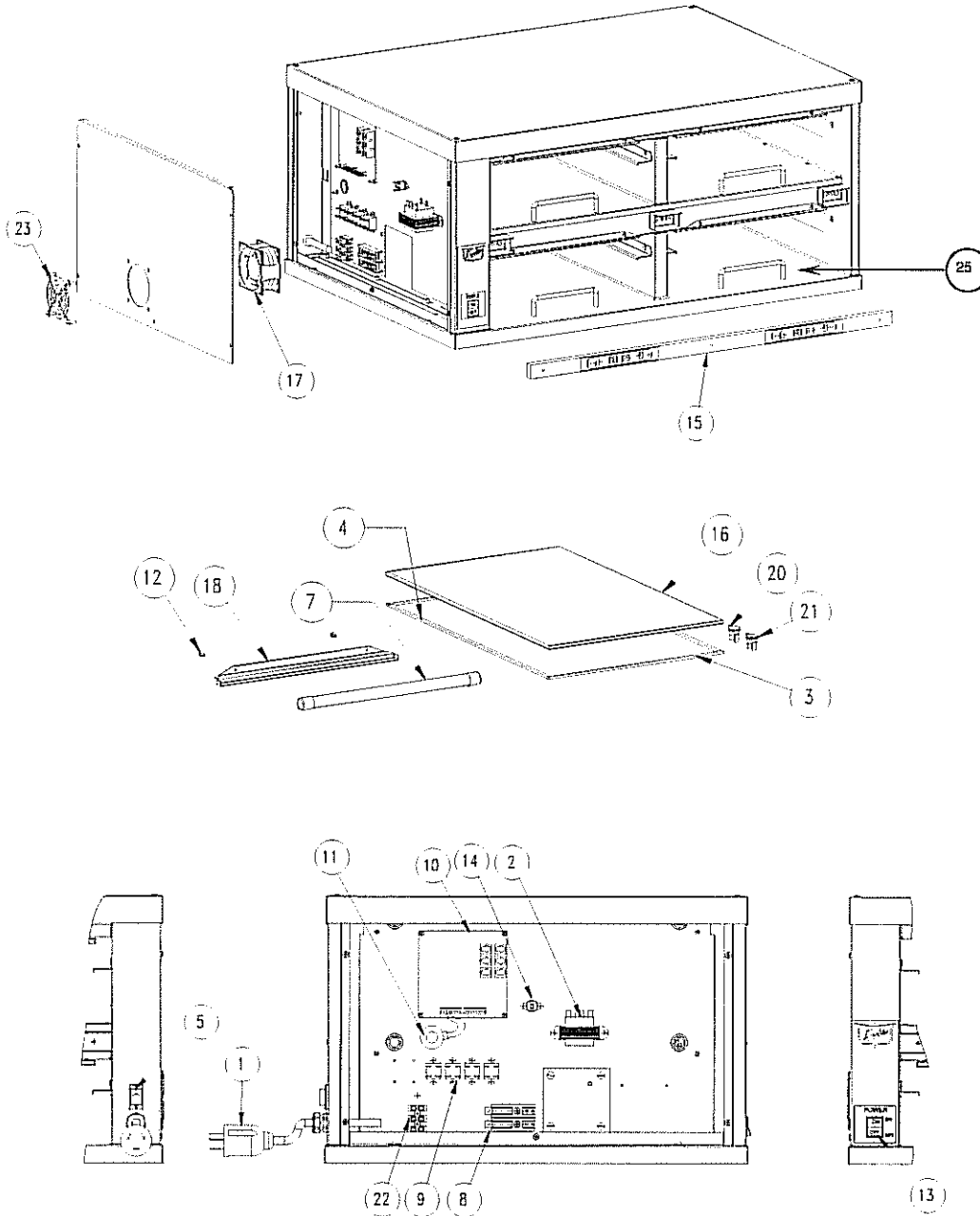

**Infra Red Holding Unit  
Exploded View**



# WIRING DIAGRAM

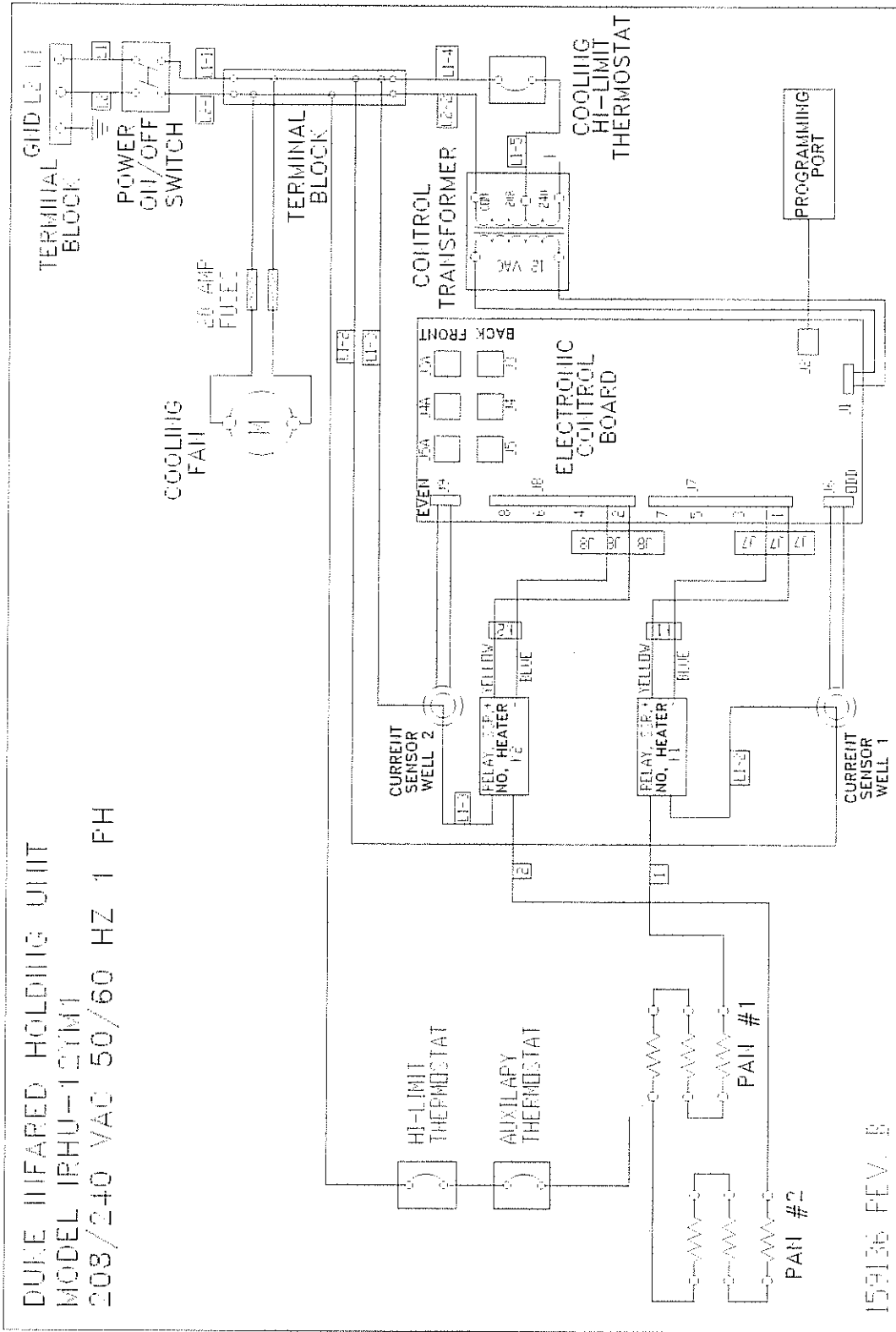

"Your Solutions Partner"

Duke Manufacturing Co.  
 2305 N. Broadway • St. Louis, MO 63102  
 800.735.3853 • 3.231.1130 • 314.231.5074 Fax  
 www.dukemfg.com

# WIRING DIAGRAM

DUKE INFRARED HOLDING UNIT  
 MODEL IRHU-22  
 208/250/240 VAC 50/60 HZ 1 PH

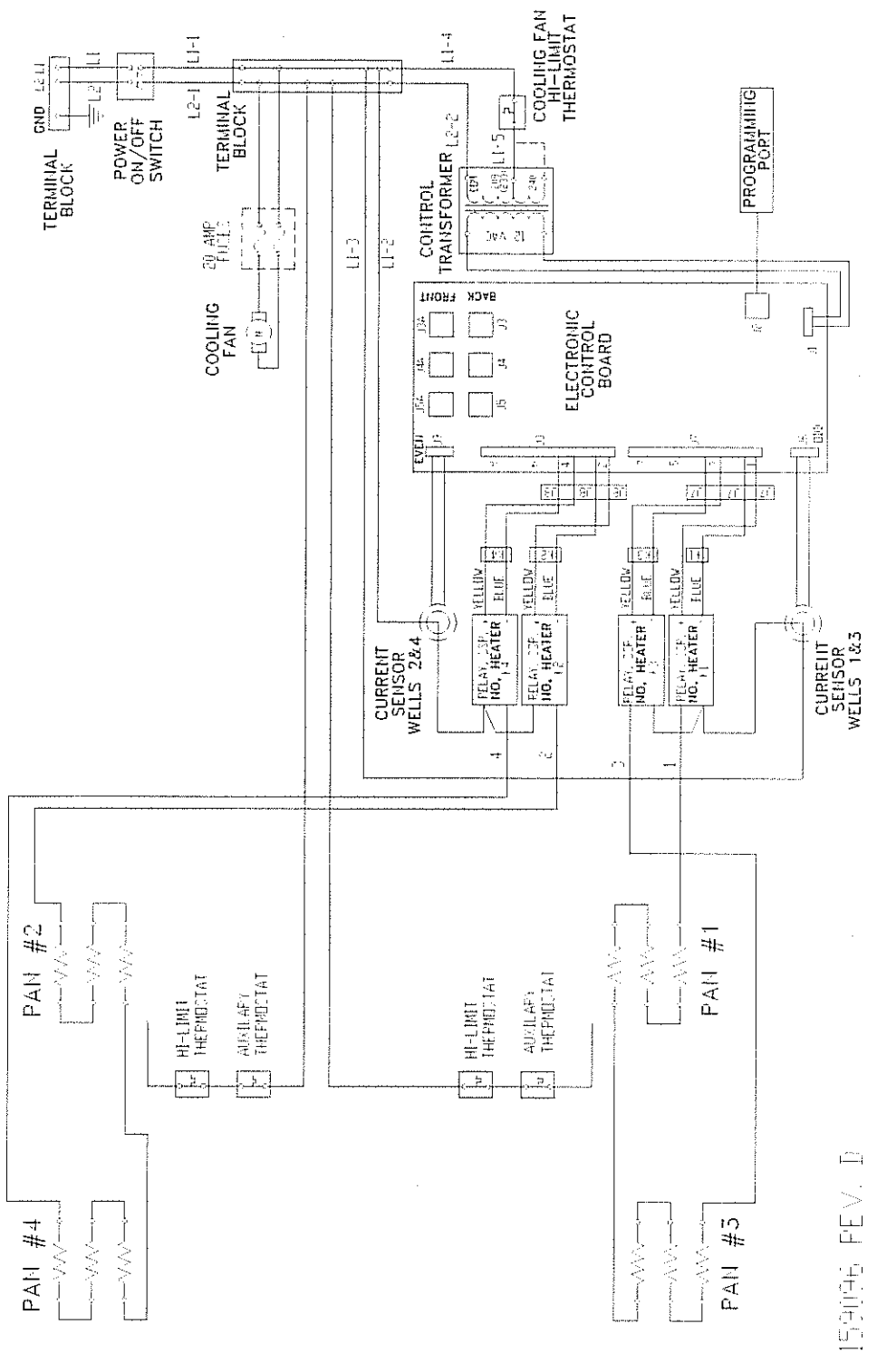

1591096 REV. D



Duke Manufacturing Co.  
 2305 N. Broadway • St. Louis, MO 63102  
 800.735.3853 • 3.231.1130 • 314.231.5074 Fax  
[www.dukemfg.com](http://www.dukemfg.com)

# WIRING DIAGRAM

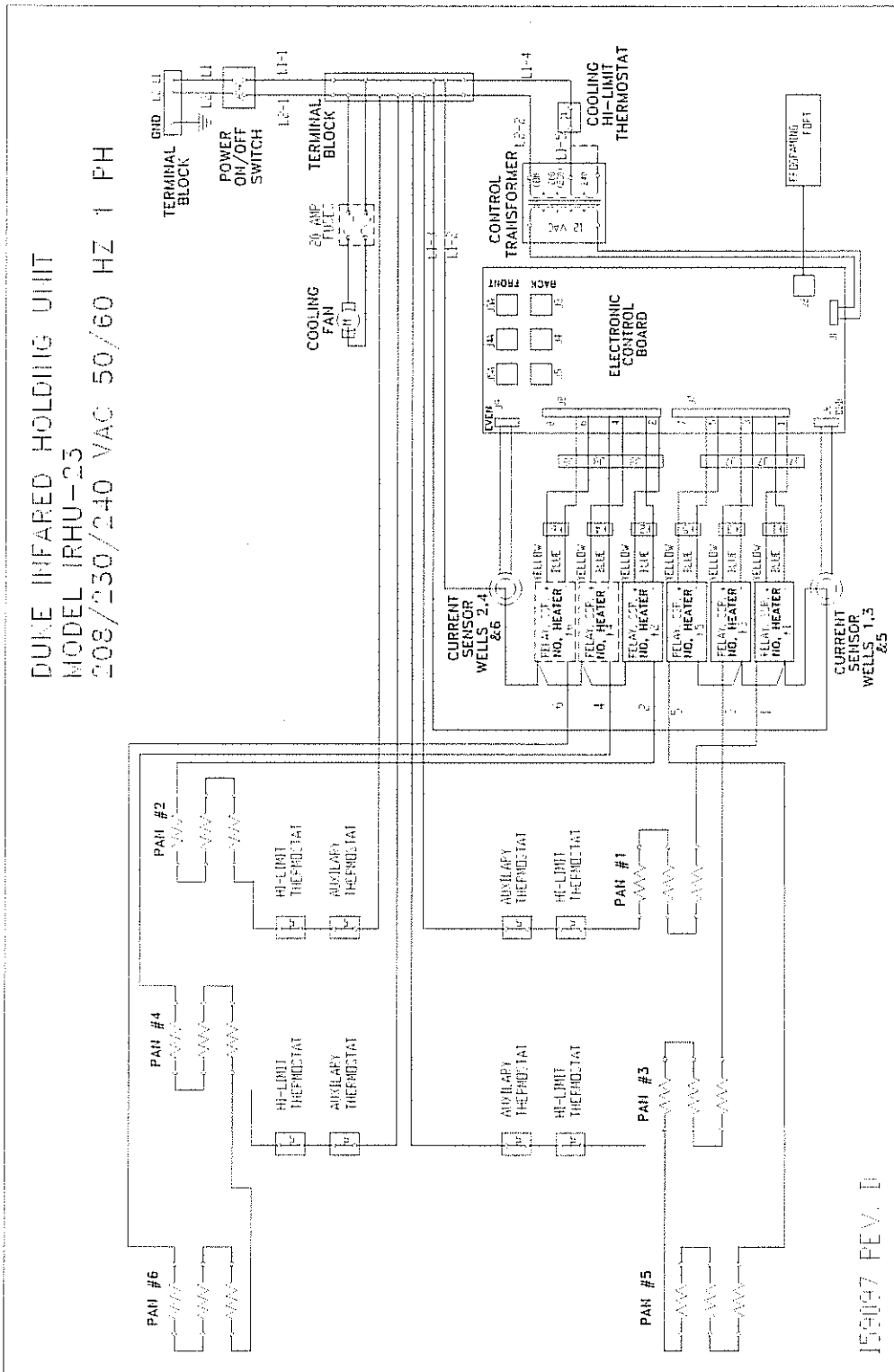

"Your Solutions Partner"

Duke Manufacturing Co.  
2305 N. Broadway • St. Louis, MO 63102  
800.735.3853 • 3.231.1130 • 314.231.5074 Fax  
www.dukemfg.com

## FOR CUSTOMER ASSISTANCE

To aid in reporting this unit in case of loss or theft, please record below the model number and serial number located on the unit. We also suggest you record all the information listed and retain for future reference.

MODEL NUMBER _____	SERIAL NUMBER _____
DATE OF PURCHASE _____	
DEALER _____	TELEPHONE _____
SERVICER _____	TELEPHONE _____

### TO PHONE:

Dial 1-800-735-DUKE (3853) or (314)231-1130

SERVICE  
PARTS  
ADDITIONAL CUSTOMER INFORMATION

### TO WRITE:

Duke Manufacturing Co.  
2305 N. Broadway  
St. Louis, MO 63102

TO ACCESS INTERNET: [www.dukemfg.com](http://www.dukemfg.com)

Please provide the following information when you write or call: model number, serial number, date of purchase, your complete mailing address (including zip code), and description of the problem.



"Your Solutions Partner"

Duke Manufacturing Co.  
2305 N. Broadway • St. Louis, MO 63102  
800.735.3853 • 3.231.1130 • 314.231.5074 Fax  
[www.dukemfg.com](http://www.dukemfg.com)

Page 19 of 20

