



**INSTALLATION
AND
OPERATING
INSTRUCTIONS**

**Models: PC-1A & MPC-1A
POPCORN POPPERS**

INTENDED FOR OTHER THAN HOUSEHOLD USE

**RETAIN THIS MANUAL FOR FUTURE REFERENCE
TOASTER MUST BE KEPT CLEAR OF COMBUSTIBLES AT ALL TIMES**



FOR YOUR SAFETY: Do not store or use gasoline or other flammable vapors and liquids in the vicinity of this or any other appliance.



WARNING: Improper installation, adjustment, alteration, service or maintenance can cause property damage, injury or death. Read the Installation, Operating and Maintenance Instructions thoroughly before installing or servicing this equipment.



Initial heating of appliance may generate smoke or fumes and must be done in a well ventilated area. Overexposure to smoke or fumes may cause nausea or dizziness.

This equipment has been engineered to provide you with year-round dependable service when used according to the instructions in this manual and standard commercial kitchen practices.

Phone: +1 (307) 634-5801
Fax: +1 (307) 637-8071
Toll Free: +1 (800) 752-0863
Website: www.apwwyott.com
E-mail: info@apwwyott.com

P/N 46710500 11/05

APW WYOTT
P.O. Box 1829
Cheyenne, WY 82003

IMPORTANT SAFETY INSTRUCTIONS



IMPORTANT: Read the following important safety instructions to avoid personal injury or death, and to avoid damage to the equipment or property.



CAUTION: These models are designed, built, and sold for commercial use. If these models are positioned so the general public can use the equipment make sure that cautions, warnings, and operating instructions are clearly posted near each unit so that anyone using the equipment will use it correctly and not injure themselves or harm the equipment.



WARNING: Check the data plate on this unit before installation. Connect the unit only to the voltage and frequency listed on the data plate. Connect only to 1 or 3 phase as listed on the data plate.



WARNING: Improper installation, operation, adjustment, alteration, service or maintenance can cause property damage, injury or death. Read and understand these instructions thoroughly before positioning, installing, maintaining or servicing this equipment.



WARNING: Electrical and grounding connections must comply with the applicable portions of the national electrical code and/or other local electrical codes.



WARNING: Disconnect device from electrical power supply and place a Tag Out-Lockout on the power plug, indicating that you are working on the circuit.



WARNING: Install per the spacing requirements listed in the installation section of this manual. We strongly recommend having a competent professional install the equipment. A licensed electrician should make the electrical connections and connect power to the unit. Local codes should always be used when connecting these units to electrical power. In the absence of local codes, use the latest version of the National Electrical Code.



WARNING: A factory authorized agent should handle all maintenance and repair. Before doing any maintenance or repair, contact APW Wyott.



WARNING: Never clean any electrical unit by immersing it in water. Turn off before cleaning surface.



WARNING: An earthing cable must connect the appliance to all other units in the complete installation and from there to an independent earth connection.



NOTICE: The unit when installed, must be electrically grounded and comply with local codes, or in the absence of local codes, with the national electrical code ANSI/NFPA70- latest edition. Canadian installation must comply with CSA-STANDARD C.22.2 Number 0 M1982 General Requirements-Canadian Electrical Code Part II, 109-M1981- Commercial Cooking Appliances.



NOTICE: Local codes regarding installation vary greatly from one area to another. The National Fire Protection Association, Inc. states in its NFPA96 latest edition that local codes are "Authority Having Jurisdiction" when it comes to requirement for installation of equipment. Therefore, installation should comply with all local codes.



WARNING: SHOCK HAZARD - De-energize all power to equipment before cleaning the equipment.



APW Wyott takes pride in the design and quality of our products. When used as intended and with proper care and maintenance, you will experience years of reliable operation from this equipment. To ensure best results, it is important that you read and follow the instructions in this manual carefully.









Installation and start-up should be performed by a qualified installer who thoroughly read, understands and follows these instruction.

If you have questions concerning the installation, operation, maintenance or service of this product, contact APW Wyott Foodservice Equipment Company's "Technical Service Department".

SAFETY PRECAUTIONS

Before installing and operating this equipment be sure everyone involved in its operation are fully trained and are aware of all precautions. Accidents and problems can result by a failure to follow fundamental rules and precautions.

The following words and symbols, found in this manual, alert you to hazards to the operator, service personnel or the equipment. The words are defined as follows:

	DANGER: This symbol warns of imminent hazard which will result in serious injury or death.	
	WARNING: This symbol refers to a potential hazard or unsafe practice, which could result in serious injury or death.	
	CAUTION: This symbol refers to a potential hazard or unsafe practice, which may result in minor or moderate injury or product or property damage.	
	NOTICE: This symbol refers to information that needs special attention or must be fully understood even though not dangerous.	

IMMEDIATELY INSPECT FOR SHIPPING DAMAGE

All containers should be examined for damage before and during unloading. The freight carrier has assumed responsibility for its safe transit and delivery. If equipment is received damaged, either apparent or concealed, a claim must be made with the delivering carrier.

A) Apparent damage or loss must be noted on the freight bill at the time of delivery. It must then be signed by the carrier representative (Driver). If this is not done, the carrier may refuse the claim. The carrier can supply the necessary forms.

B) Concealed damage or loss if not apparent until after equipment is uncrated, a request for inspection must be made to the carrier within 15 days. The carrier should arrange an inspection. Be certain to hold all contents and packaging material.

Installation and start-up should be performed by a qualified installer who thoroughly read, understands and follows these instructions.

Location Of Data Plate:

The data plate is located on the back side of the front panel.

TABLE OF CONTENTS

Important Safety Instructions.....	2
Safety Precautions	3
Specifications & Dimensions.....	4
Installation.....	4
Operating Instructions.....	5
Cleaning/Maintenance.....	5
Service/Repair.....	6
Troubleshooting Guide.....	6
Wiring Diagrams.....	7
Parts Lists.....	8
MPC-1A.....	8
PC-1A.....	10
Warranty.....	12

SPECIFICATIONS AND DIMENSIONS

- Non jamming agitator motor gently turns to distribute kernels evenly over heated surface.
- Motor and controls located away from kettle heat in vented part of top cabinet.
- Produces a kettle of popcorn every 2 1/2 minutes.
- Popcorn kept hot by using heating element on the bottom and bulb heat on the top.
- Interiors are stainless steel.
- Cabinet constructed of stainless steel and tempered glass.
- Kettle made of heavy-gauge aluminum surrounded by stainless steel.
- Kettle is secured to cabinet through double-hung, stainless steel brackets.

MODEL	SIZE	VOLTS	WATTS	AMPS	DIMENSIONS	SHIP WT.
MPC-1A	6 - 8 oz	120	1125	9.4	25 1/2"H x 19"W x 15 5/8" D	63#
MPC-1A	6 - 8 oz	240	1125	4.7	25 1/2"H x 19"W x 15 5/8" D	63#
PC-1A	8 -10 oz	120	1643	13.7	30"H x 22 1/4"W x 21 1/4" D	75#
PC-1A	8 -10 oz	240	1643	6.8	30"H x 22 1/4"W x 21 1/4" D	75#

INSTALLATION

1. Always clean equipment thoroughly before first use. (See general cleaning instructions.)
2. Check rating label for your model designation and electrical rating.
3. Locate equipment on level counter and plug into a grounded outlet so the plug is accessible. (See individual description for electrical loads.) On units bearing the CE marking, the appliance must be connected by an earthing cable to all other units in the complete installation and, hence, to an independent earth connection.
4. Install heat lamp in lamp holder at top rear of cabinet.
5. Slide drawer into slot at base of cabinet.
6. Install kettle by inserting locking hinge pin through holes in support bracket and kettle.
7. Insert kettle plug into ceiling mounted receptacle. Twist plug to lock.
8. Install kettle hinged covers by inserting tabs into support bracket slots. Cover with lifting knob must be installed on operator side of kettle.
9. Install acrylic doors.

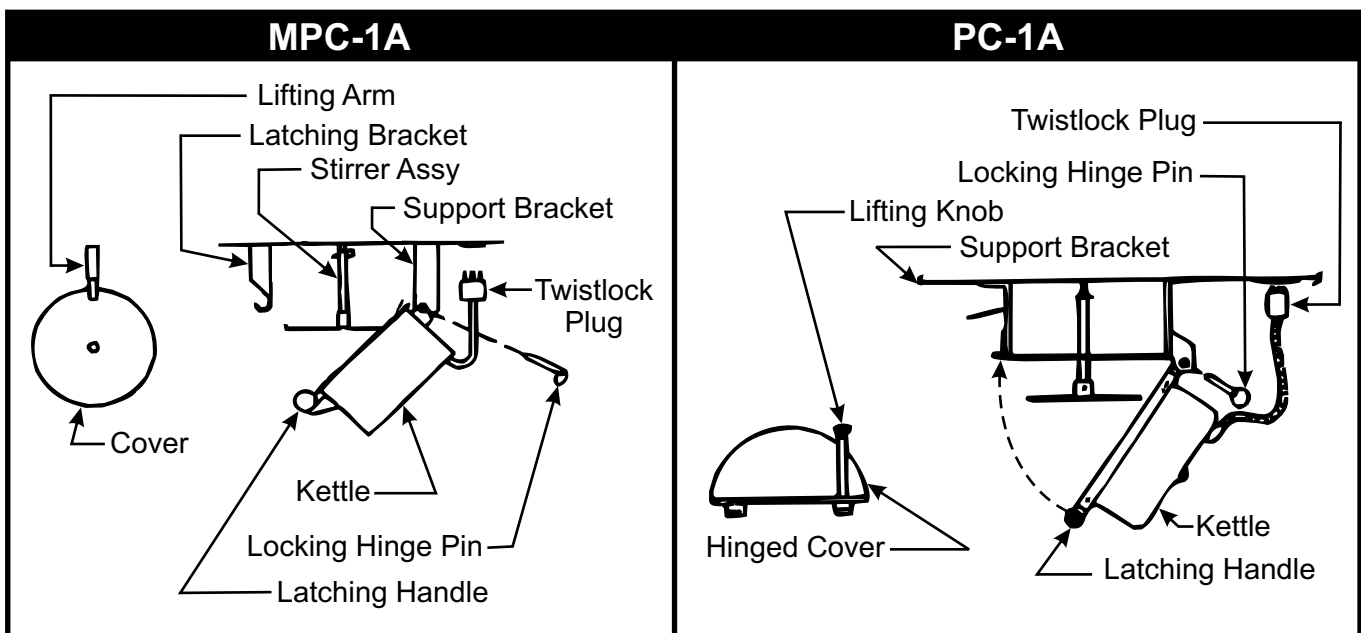

OPERATING INSTRUCTIONS

1. All foodservice equipment should be operated by trained personnel.
2. Do not allow customers to come in contact with any surface labeled "CAUTION/HOT."
3. Where applicable, never pour cold water into dry, heated units.
4. Where applicable, do not cook, warm or hold food directly in liner pans (well pans). Always use steam table pans, insets and so forth.
5. Never hold food below 150°F (66°C).

6-8 ounce (170-230 gm) Popper only:

6. Raise kettle to support bracket and latch by turning handle clockwise.
7. Turn on POWER/DISPLAY and KETTLE/STIRRER switches to preheat kettle for 8 minutes.
8. Raise hinged kettle cover with lifting knob and add 1/4-1/3 cup (.06-.08 litre) popcorn oil, 3/4 to 1 cup (6 ounces or 0.18 to 0.24 litre or 170 grams) popcorn and desired amount of salt. Close cover. Avoid spilling oil on exterior of kettle.
9. Leave KETTLE/STIRRER switch on until popping is completed. Unlatch kettle. Gradually lower kettle to dump all popcorn. Do not allow kettle to drop abruptly. CAUTION: Kettle is marked "CAUTION HOT." DO NOT TOUCH KETTLE, USE INSULATED HANDLE.
10. Additional batches of popcorn can be popped immediately.
11. Always turn off KETTLE/STIRRER switch when not popping corn.
12. CAUTION: DO NOT LEAVE POPPER UNATTENDED WHEN IN USE.

10 ounce (284 gm) Popper only:

6. Raise kettle to support bracket and latch by turning handle clockwise.
7. Turn on POWER/DISPLAY and KETTLE switches to preheat kettle for 10 minutes.
8. Raise hinged kettle cover with lifting knob and add 1/3 cup (.08 litre) popcorn oil, 1 1/3 (10 ounces or .32 litre or 284 grams) popcorn and desired amount of salt. Close cover. Avoid spilling oil on exterior of kettle.
9. Turn on STIRRER switch until popping is completed. Unlatch kettle. Gradually lower kettle to dump all popcorn. Do not allow kettle to drop abruptly. CAUTION: Kettle is marked "CAUTION HOT." DO NOT TOUCH KETTLE, USE INSULATED HANDLE.
10. Additional batches of popcorn can be popped immediately.
11. Always turn off KETTLE/STIRRER switches when not popping corn.
12. CAUTION: DO NOT LEAVE POPPER UNATTENDED WHEN IN USE.

Suggestions

1. Keep access doors open when popping to reduce cabinet moisture.
2. Use POWER/DISPLAY switch to warm and display popped corn.

CLEANING/MAINTENANCE

1. NEVER clean any electrical unit by immersing it in water. Unplug unit before surface cleaning.
2. Always clean equipment thoroughly before first use. Clean unit daily. Except where noted on charts, use warm, soapy water. Mild cleaners and PLASTIC scouring pads may be used to remove baked-on food and water scale.
3. Unplug all units before cleaning or servicing. All service should be performed by an APW Wyott authorized service agency.
4. STAINLESS STEEL: To remove normal dirt or product residue from stainless steel, use ordinary soap and water (with or without detergent) applied with a sponge or cloth. Dry thoroughly with a clean cloth. Never use vinegar or corrosive cleaner. Do not use chlorine based cleaners.
5. To prevent build-up of excess oil and salt, clean daily when kettle is still warm. Allow sufficient cool down time before removing kettle for cleaning. Do NOT immerse kettle in water.
6. To remove grease and food splatter or condensed vapors that have baked on the equipment, apply cleaners to a damp cloth or sponge and rub cleanser on the metal in the direction of the polished lines



on the metal. Rubbing cleanser as gently as possible in the direction of the polished lines will not mar the finish of the stainless steel. NEVER RUB WITH A CIRCULAR MOTION. Soil and burnt deposits which do not respond to the above procedure can usually be removed by rubbing the surface with SCOTCH-BRITE scouring pads or STAINLESS scouring pads.

7. Pull spring clip to remove stirrer from drive shaft. Align hole in stirrer and drive shaft to reinstall clip.
8. Lift off kettle cover. A mild abrasive cleaner and PLASTIC scouring pad may be used to remove oil build-up on any of the kettle parts.
9. Remove all unpopped corn from drawer and wipe out entire cabinet. Clean cabinet and doors with mild soap and water. Dry with soft towel.

DO NOT USE ordinary steel wool as any particles left on the surface will rust.

NEVER USE a wire brush, steel or abrasive scouring pads (except stainless), scraper, file or other steel tools. Surfaces which are marred collect dirt more rapidly and become more difficult to clean. Marring also increases the possibility of corrosive attack.

NEVER USE any corrosive cleaner. Use only cleaners approved for stainless steel.

 **WARNING:** Unit is not waterproof. NEVER clean any electrical unit by immersing it in water. Turn off unit before cleaning surface. 

 **WARNING:** *SHOCK HAZARD* - To avoid electrical shock, always de-energize all power to equipment before performing cleaning or maintenance. 

SERVICE / REPAIR

NOTE: THIS APPLIANCE MUST ONLY BE SERVICED BY AN AUTHORIZED AGENT.

NOTE: Parts protected by the manufacturer or his agent are not to be adjusted by the installer, unless the installer is an authorized service agent.

Maintenance and repair should be handled by a factory authorized agent. Before doing any maintenance or repair, contact APW Wyott Foodservice Equipment Company at (800) 7520863 or (800) 783-2251, Monday - Friday, 7 am-4:30 pm Mountain Standard Time.

If you have any questions or problems, contact your nearest APW Wyott Service Representative.

TROUBLE SHOOTING GUIDE

If the unit fails to operate, check the following:

1. Is the unit connected to a live power source?
2. Check circuit breaker?
3. Is power switch on?
4. Check the data plate. Are you operating the unit on proper voltage?
5. Is the supply cord damaged? If it is, it should only be replaced by an identical supply cord.

If the above checks out and you still have problems, call an APW WYOTT authorized service agency.

NOTICE: Service work should be performed only by a qualified technician who is experienced in and knowledgeable with the operation of commercial gas, electric, steam cooking equipment. Contact the Authorized Service Agency for reliable service, dependable advice or other assistance and for genuine factory parts.

Warranty will be void and the manufacturer is relieved of all liability if:

- (A) Service work is performed by other than an APW WYOTT Authorized Service Agency or
- (B) Other than Genuine APW WYOTT replacement parts are installed.

A current listing of all authorized APW WYOTT authorized parts/service distributors is included with this product manual at the time of shipment. In the absence of this list you can call the APW WYOTT 24 hour Service Hot Line which gives access to the nearest Authorized APW WYOTT parts/service distributor. Call 1-800-733-2203.

PC-1A WIRING DIAGRAM

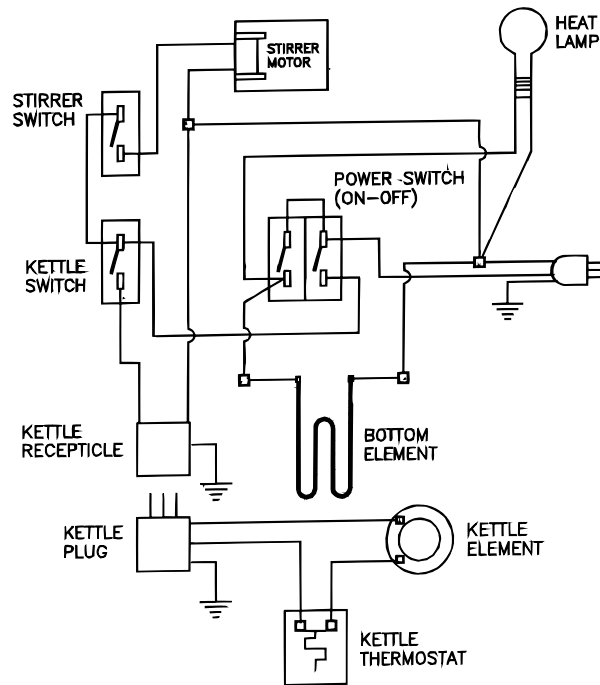

MPC-1A WIRING DIAGRAM

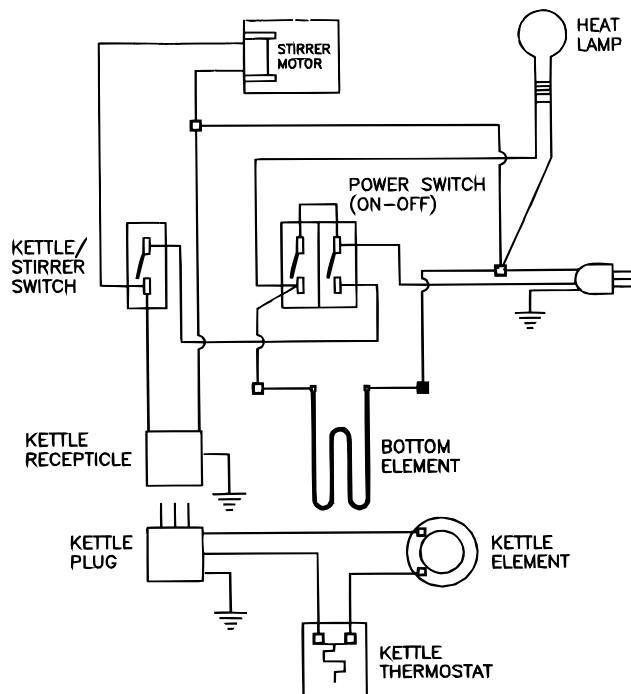

PARTS LIST MPC-1A

ITEM	P/N	DESCRIPTION	ITEM	P/N	DESCRIPTION
1	46612100	Side Glass	39	45401500	Element-Kettle 120V-1000W
2	46612200	Front Glass	39A	45401400	Element-Kettle 240V-1000W
3	46609900	Vinyl Molding-glass	40	46913100	Thermostat-Kettle
4	46635900	Right Front Door	41	1101500	Conduit Connector-Kettle
5	46636100	Left Front Door	42	45534000	Anti-Short Bushing-Kettle
6	46632400	Door Hinge	43	46603000	Flex Conduit -Kettle
7	46633700	Door Adjustment Plate	44	1610000	Twistlock Plug-Kettle
8	48373300	Door Hinge Rod	45	46603200	Twistlock Receptacle
9	48916500	Knob-Door	46	1504100	Lamp Socket
10	46605800	Door Magnet Plate	47	46614300	Lamp Bulb 120V-75W
11	8705000	Door Magnet	47A	46627100	Lamp Bulb 230V-100W
12	46634200	Bottom Door Assembly	48	47591400	Switch-Power/Display
13	46633600	Top Cover-Stainless	49	47591300	Switch-Kettle/Stirrer
14	46633900	Top Cover-Yellow	50	47255900	Power Cord
15	46637600	Top Cover-Red	51	45576800	Rubber Foot
16	46636300	Inner Top Assembly	52	46607800	1 Cup Measuring Cup
17	46617700	Bottom Assembly	53	46607900	1/4 Cup Measuring Cup
18	45401600	BTM Rope Element 120V-27W	54		
19	46604900	Crumb Drawer	55		
20	48529700	Motor-Stirrer Drive 120V	56	1196100	Wire Nut
20A	48491600	Motor-Stirrer Drive 240V	57	8967400	Strain Relief Bushing
21	46634700	Stirrer Shaft Assembly	58	46634900	Cool Handle
22	46633400	Stirrer Shaft	59	21765600	Marketing Label MPC-1A
23	46602600	Stirrer Coupling	60	45809700	Control Plate
24	46623200	Stirrer Wire	61	8300700	Roll Pin
25	48895000	Hairpin Cotter		8967200	Hole Bushing
26	46635000	Lid Assembly-Kettle		48912000	Jiffy Clip
27	46633100	Magnet-Lid		8424000	10-24 Acorn Nut
28	46635200	Magnet Cup Assembly		8422300	10-24 Hex Nut
29	46632000	Hanger Bracket-Kettle Right		8422400	10-24 Green Hex Nut
30	46632100	Latch Bracket-Kettle		8427400	1/4-20 Acorn Nut
31	48894900	Cotterless Hitch Pin		8414500	10-32 Hex Nut
32	46635300	Kettle Assembly-Complete		8506000	#10 External Lockwasher
33	46621800	Kettle-Aluminum Pot Only		8515000	Fender Washer
34	46635100	Cover Assembly-Kettle		8110100	6-32x3/4 Pan Head Screw
35	46602000	Handle-Kettle		8158500	10-24x3/8 Screw
36	46632900	Handle Shaft-Kettle		8169700	10-32x3/8 Truss Head
37	46602300	Latching Bar-Kettle		48893900	1/4-20x2 Allen Stud
38	46622200	Element Bracket-Kettle	For Unit Serial Number 9207001 and Above		

MPC-1A POPCORN POPPER EXPLODED VIEW

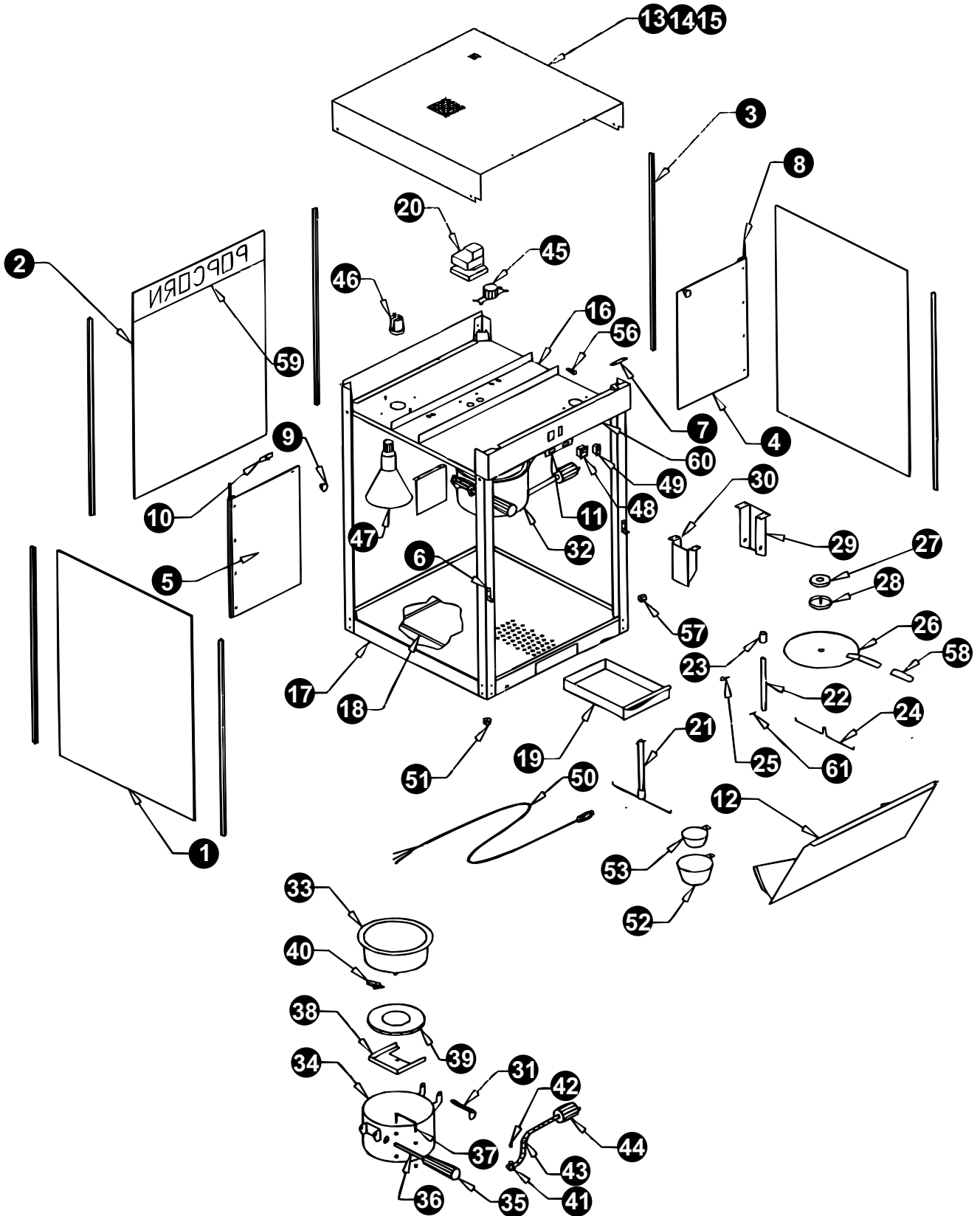

PARTS LIST PC-1A

ITEM	P/N	DESCRIPTION	ITEM	P/N	DESCRIPTION
1	46644400	Top Wrapper	41	45534000	Anti-Short Bushing
2	46644900	Inner Top Assembly	42	1610000	Twistlock Plug-Kettle
3	46640500	Bottom	43	46603200	Twistlock Receptacle-Kettle
4	45576800	Foot (each)	44	47541000	Lamp Bulb 120V
5	46640400	Inner Bottom	45	46614800	Lamp Bulb 240V
6	46604900	Crumb Drawer	46	46605000	Lamp Mounting Bracket
7	46644000	Left Front Corner Post	47	47300300	Porcelain Lamp Holder
8	46644100	Right Front Corner Post	48	46603300	Lamp Reflector
9	46640600	Front Wire Raceway	49	46910900	Thermostat-Kettle
10	46640900	Left Rear Corner Post	50	48529700	Stirrer Motor 120V
11	46641000	Right Rear Corner Post	51	48491600	Stirrer Motor 240V
12	46641100	Rear Glass Support	52	1196100	Porcelain Wire Nut
13	46641200	Vinyl Glass Molding	53	45401600	Bottom Heating Element
14	46641300	Tempered Glass	54	45401200	Element-Kettle 120V-1300W
15	46605800	Door Plate	55	45401300	Element-Kettle 240V-1300W
16	46632400	Door Hinge	56	47255900	Power Cord
17	46642300	Right Door	57	8967400	Strain Relief Bushing
18	46644300	Left Door	58	47591400	On-Off Switch-Main Power
19	46643900	Bottom Slant Door Assembly	59	47591300	On-Off Switch-Kettle/Stirrer
20	46601600	Kettle Assembly-Complete 120V	60	8705000	Magnet-Door
21	46642700	Kettle Assembly-Complete 240V	61	48916500	Knob-Lid, Door
22	46601500	Kettle Casting Only	62	46607800	Measuring Cup
23	46602200	Element Bracket	63	21765600	Marketing Label
24	46601800	Kettle Outer Wrapper	64	45810000	Control Plate
25			65	48373300	Door Hinge Rod
26	46602401	Kettle Latch Shaft			
27	46602300	Kettle Latch		8967200	Bushing Hole 0.5"
28	46602000	Shaft Handle		8510000	3/8 Flat Washer
29	48894900	Cotterless Hitch Pin		8506000	#10 External Lock Washer
30	46604400	Kettle Support Bracket		8422400	10-24 Green Hex Nut
31	46602600	Stirrer Coupling		8422300	10-24 Hex Nut
32	46602700	Stirrer Paddle		8424000	10-24 Acorn Nut
33	46602500	Stirrer Shaft		8414500	10-32 Hex Nut
34	46602900	Stirrer Shaft Assembly		8431700	1/4-20 Hex Nut
35	8300700	Roll Pin		8427400	1/4-20 Acorn Nut
36	48895000	Hairpin Cotter		8110100	6-32x3/4 Screw
37	46605500	Kettle Lid with Handle		8158500	10-24x3/8 Screw
38	46601900	Kettle Lid Pan		8162500	10-32x1/4 Screw
39	46603000	Flex Conduit-Kettle		8169700	10-32x3/8 Screw
40	1101500	Conduit Connector-Kettle		48896900	1/4-20x1 3/4 Alhd th S/S

PC-1A POPCORN POPPER EXPLODED VIEW

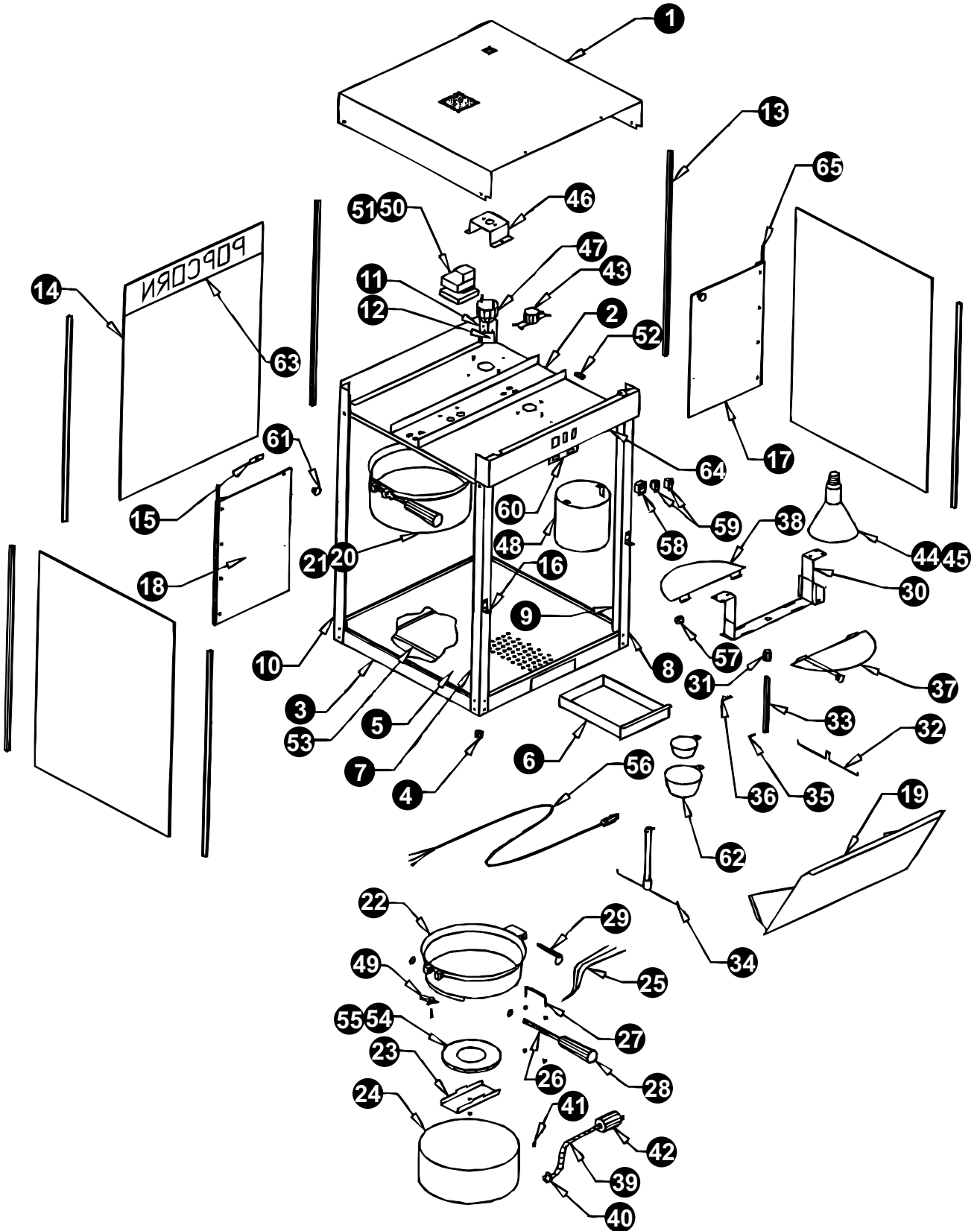

APW WYOTT EQUIPMENT LIMITED WARRANTY

APW Wyott Foodservice Equipment Company warrants its equipment against defects in materials and workmanship, subject to the following conditions:

This warranty applies to the original owner only and is not assignable.

Should any product fail to function in its intended manner under normal use within the limits defined in this warranty, at the option of APW Wyott such product will be repaired or replaced by APW Wyott or its Authorized Service Agency. APW Wyott will only be responsible for charges incurred or service performed by its Authorized Service Agencies. The use of other than APW Wyott Authorized Service Agencies will void this warranty and APW Wyott will not be responsible for such work or any charges associated with same. The closest APW Wyott Authorized Service Agent must be used.

This warranty covers products shipped into the 48 contiguous United States, Hawaii, metropolitan areas of Alaska and Canada. There will be no labor coverage for equipment located on any island not connected by roadway to the mainland.

Warranty coverage on products used outside the 48 contiguous United States, Hawaii, and metropolitan areas of Alaska and Canada may vary. Contact the international APW Wyott distributor, dealer, or service agency for details.

Time Period

One year for parts and one year for labor, effective from the date of purchase by the original owner. The Authorized Service Agency may, at their option, require proof of purchase. Parts replaced under this warranty are warranted for the un-expired portion of the original product warranty only.

Exceptions

***Gas/Electric Cookline:** Models GCB, GCRB, GF, GGM, GGT, CHP-H, EF, EG, EHP. Three (3) Year Warranty on all component parts, except switches and thermostats. (2 additional years on parts only. No labor on second or third year.)

***Broiler Briquettes, Rock Grates, Cooking Grates, Burner Shields, Fireboxes:** 90 Day Material Only. No Labor.

***Heat Strips:** Models FD, FDL, FDD, FDDL. Two (2) Year Warranty on element only. No labor second year.

***Glass Windows, Doors, Seals, Rubber Seals, Light Bulbs:** 90 Day Material Only. No Labor.

In all cases, parts covered by extended warranty will be shipped FOB the factory after the first year.

Portable Carry In Products

Equipment weighing over 70 pounds or permanently installed will be serviced on-site as per the terms of this warranty. Equipment weighing 70 pounds or under, and which is not permanently installed, i.e. with cord and plug, is considered portable and is subject to the following warranty handling limitations. If portable equipment fails to operate in its intended manner on the first day of connection, or use, at APW Wyott's option or its Authorized Service Agency, it will be serviced on site or replaced.

From day two through the conclusion of this warranty period, portable units must be taken to or sent prepaid to the APW Wyott Authorized Service Agency for in-warranty repairs. No mileage or travel charges are allowed on portable units after the first day of use. If the customer wants on-site service, they may receive same by paying the travel and mileage charges. Exceptions to this rule: (1) countertop warmers and cookers, which are covered under the Enhanced Warranty Program, and (2) toasters or rollergrills which have in store service.

Exclusions

The following conditions are not covered by warranty:

*Equipment failure relating to improper installation, improper utility connection or supply and problems due to ventilation.

*Equipment that has not been properly maintained, calibration of controls, adjustments, damage from improper cleaning and water damage to controls.

*Equipment that has not been used in an appropriate manner, or has been subject to misuse or misapplication, neglect, abuse, accident, alteration, negligence, damage during transit, delivery or installation, fire, flood, riot or act of god.

*Equipment that has the model number or serial number removed or altered.

If the equipment has been changed, altered, modified or repaired by other than an Authorized Service Agency during or after the warranty period, then the manufacturer shall not be liable for any damages to any person or to any property, which may result from the use of the equipment thereafter.

This warranty does not cover services performed at overtime or premium labor rates. Should service be required at times which normally involve overtime or premium labor rates, the owner shall be charged for the difference between normal service rates and such premium rates. APW Wyott does not assume any liability for extended delays in replacing or repairing any items beyond its control.

In all cases, the use of other than APW Wyott Authorized OEM Replacement Parts will void this warranty.

This equipment is intended for commercial use only. Warranty is void if equipment is installed in other than commercial application.

Water Quality Requirements

Water supply intended for a unit that has in excess of 3.0 grains of hardness per gallon (GPG) must be treated or softened before being used. Water containing over 3.0 GPG will decrease the efficiency and reduce the operation life of the unit.

Note: Product failure caused by liming or sediment buildup is not covered under warranty.

"THE FOREGOING WARRANTY IS IN LIEU OF ANY AND ALL OTHER WARRANTIES EXPRESSED OR IMPLIED INCLUDING ANY IMPLIED WARRANTY OF MERCHANTABILITY OR FITNESS FOR PARTICULAR PURPOSES AND CONSTITUTES THE ENTIRE LIABILITY OF APW WYOTT. IN NO EVENT DOES THE LIMITED WARRANTY EXTEND BEYOND THE TERMS STATED HEREIN."

9/05